

A PROJECT OF THE  
PEORIA PARK DISTRICT  
PEORIA, ILLINOIS

**CURB AND GUTTER IMPROVEMENTS NORTH/UPPER  
BRADLEY PARK**

PEORIA, ILLINOIS



PROJECT # 20-003  
MAY 19, 2020

PROJECT MANUAL

PACKAGE # \_\_\_\_\_

PROJECT MANUAL INCLUDING SPECIFICATIONS FOR:

**CURB AND GUTTER IMPROVEMENTS NORTH/UPPER  
BRADLEY PARK  
PEORIA, ILLINOIS**

**ARCHITECT:** ZUMWALT & ASSOCIATES  
ATTN: TREVOR ALEXANDER  
1040 W. OLYMPIA DRIVE  
PEORIA, IL 61615  
(309) 692-5074

---

**OWNER:** PLEASURE DRIVEWAY AND PARK DISTRICT OF PEORIA,  
PEORIA, ILLINOIS

**TRUSTEES:** ROBERT L. JOHNSON, SR., PRESIDENT  
JACQUELINE J. PETTY  
JOSEPH CASSIDY  
JOYCE HARANT  
MATTHEW P. RYAN  
NANCY L. SNOWDEN  
MIC WILLIAMS

**PROJECT MANAGER:** MARY HARDEN  
PLANNING, DESIGN & CONSTRUCTION DIVISION  
BRADLEY PARK EQUIPMENT SERVICE  
1314 N. PARK ROAD  
PEORIA, ILLINOIS 61604  
TELEPHONE:(309) 686-3386

**ADMINISTRATIVE STAFF:** EMILY CAHILL, EXECUTIVE DIRECTOR  
BRENT WHEELER, DEPUTY DIRECTOR  
MATT FREEMAN, SUPERINTENDENT OF PARKS  
KARRIE ROSS, SUPERINTENDENT OF FINANCE  
AND ADMINISTRATIVE SERVICES  
BECKY FREDRICKSON, SUPERINTENDENT OF PLANNING,  
DESIGN AND CONSTRUCTION  
SHALESSE PIE, SUPERINTENDENT OF HUMAN  
RESOURCES

\*\*\*\*\*

Address all communications regarding this work to the Project Manager listed above.

**ADVERTISEMENT FOR BIDS**

Sealed bids will be received by the Peoria Park District, Peoria, Illinois, hereinafter known as the Owner, for the following project:

Curb and Gutter Improvements North/Upper  
Bradley Park  
Peoria, IL 61604

It is the intent of the Owner to receive Base Bids & Alternates for the project listed above.

Sealed bids will be received until 1:30 p.m. on Tuesday, June 2, 2020 prevailing time, by the Owner, at the Peoria Park District Administrative Office, 1125 W. Lake Ave., Peoria, Illinois 61614. (The Board Room clock shall be the official time keeping device in respect to the bid submission deadline.)

An electronic file including Bid Documents is available at [www.peoriaparks-planning.org](http://www.peoriaparks-planning.org) at no charge. Bid Documents, including Plans, Specifications and Interpretations for this project may be obtained at the Planning, Design & Construction Department, Bradley Park Equipment Service, 1314 N. Park Road, Peoria, IL 61604. Telephone (309) 686-3386. A non-refundable plan deposit of Thirty-Five dollars (\$35.00) will be charged for each printed set of Bid Documents.

A list of planholders can be obtained upon request. This information will be available up to twenty-four (24) hours prior to the scheduled bid opening time. **After that deadline, no information pertaining to the project will be given.**

A 10% Bid Bond is required, and is to be included with the Bid Proposal. The successful Bidder will be required to furnish a 100% Performance Bond and a 100% Labor and Materials Payment Bond within ten (10) days of formal Award of Contract.

The general prevailing rate of wage for the Peoria area shall be paid for each craft or type of worker needed to execute this contract or perform this work as required by the State of Illinois Department of Labor. Additionally, it is required that provisions of the Illinois Preference Act, the Illinois Drug Free Workplace Act, and the Substance Abuse Prevention on Public Works Act must be adhered to. Bidders are also advised that contract documents for this project include the non-discrimination, equal opportunity and affirmative action provisions in the Human Rights Act and rules and regulations of the Department of Human Rights. The Peoria Park District is an AA/EEO organization and encourages participation by minority and female-owned firms.

The Peoria Park District reserves the right to reject any or all bids, waive technical deficiencies, informalities or irregularities or rebid any project.

PLEASURE DRIVEWAY AND PARK DISTRICT  
OF PEORIA, ILLINOIS

BY: ROBERT L. JOHNSON, SR., President

BY: CARLEY ALLENSWORTH, Secretary

**TABLE OF CONTENTS**

TITLE PAGE(S)	1-2
INVITATION TO BID	3
TABLE OF CONTENTS	4
BIDDING DOCUMENTS:	
- SUPPLEMENTARY INSTRUCTIONS TO BIDDERS	5-9
- BID FORM(S)	10-13
- CERTIFICATE OF EQUAL EMPLOYMENT OPPORTUNITY COMPLIANCE FOR CONTRACTORS AND VENDORS	14
- WORKFORCE PROFILE AND INSTRUCTIONS	15-17
- MINORITY/WOMEN OWNED CONTACT SHEET	18
- SEXUAL HARASSMENT POLICY STATEMENT	19-21
- CERTIFICATION OF COMPLIANCE OF LISTED PROVISIONS AND LAWS	
- MAJOR SUBCONTRACTORS LIST	23
- DIRECTORY OF MINORITY & WOMEN OWNED BUSINESS ENTERPRISES	24-29
- ILLINOIS DEPARTMENT OF LABOR - PREVAILING WAGES FOR PEORIA COUNTY	
- SAMPLE ADDENDUM FORM	36
CONTRACT DOCUMENTS:	
- AGREEMENT BETWEEN OWNER AND CONTRACTOR	37-42
- PERFORMANCE BOND	43-44
- LABOR & MATERIALS PAYMENT BOND	45-46
- CONTRACTOR'S AFFIDAVIT	47
- LIEN WAIVER FORMS	48-51
- WEEKLY WORKFORCE REPORT	52-53
- CERTIFIED PAYROLL FORM	
- W-9	
- SUPPLEMENTAL GENERAL CONDITIONS	62-66
PROJECT SPECIFICATIONS:	
GENERAL REQUIREMENTS:	
<u>DIVISION 010000: GENERAL REQUIREMENTS</u>	77-88
EXHIBITS:	
ATTACHMENT A6 - INSURANCE REQUIREMENTS	
DRAWINGS:	
C0.0	COVER SHEET
V1.1	EXISTING TOPOGRAPHY SURVEY- NORTH
V1.2	EXISTING TOPOGRAPHY SURVEY- SOUTH
C1.1	OVERALL SITE PLAN & GENERAL NOTES
CD1.1	SITE REMOVAL PLAN- NORTH
CD1.2	SITE REMOVAL PLAN- SOUTH
C2.1	SITE GRADING PLAN- NORTH
C2.2	SITE GRADING PLAN- SOUTH
C3.1	STORMWATER POLLUTION PREVENTION PLAN, DETAILS AND NOTES

# SUPPLEMENTARY INSTRUCTIONS TO BIDDERS

## 1. INSTRUCTIONS TO BIDDERS

- A. "Instructions to Bidders", AIA Document A701, 1997 Editions, published by the American Institute of Architects, including revisions adopted before date of this Project Manual, is hereby made part of these specifications with same force and effect as though set forth in full.
- B. The following modifies, changes, deletes from or adds to the **Instructions to Bidders** (AIA Document A701, 1997 Edition). Where any Article of the Instructions to Bidders is modified or any Paragraph, Subparagraph or Clause thereof is modified or deleted by these Supplementary Conditions, the unaltered provisions of that Article, Paragraph, Subparagraph or Clause shall remain in effect.
- C. Parenthesis ( ) indicates the appropriate section and Subparagraph of the Instructions to Bidders which each paragraph of the Supplementary Instructions to Bidders modifies or refers to.

## 2. PROJECT DESCRIPTION

- A. The Project description generally is as follows:
  - 1. **BASE BID:**  
Pavement edge removal and removal of existing curb and gutter, installation of inlets, storm sewer and new curb and gutter.
  - 2. **ALTERNATES:**  
Add Alternate 1: Replacement of curb and gutter in area indicated on plan set.  
Add Alternate 2: Replacement of curb and gutter in area indicated on plan set.  
Add Alternate 3: Replacement of curb and gutter in area indicated on plan set.  
Add Alternate 4: Replacement of curb and gutter in area indicated on plan set.
- B. **PRE-BID MEETING :**
  - 1. A pre-bid meeting will be held at the project site in Bradley Park on Tuesday, May 26, 2020 at 9 :30 a.m.

## 3. CODES AND PERMITS

- A. **COSTS ASSOCIATED WITH REGULATORY COMPLIANCE.** All Work performed in connection with this Project shall be in compliance with the requirements of all applicable local, state, and federal laws, regulations, and rules, as well as the requirements of the Construction Documents. The Bid Price shall reflect all costs of compliance to those requirements, whether or not specifically stated in the Construction Documents or specific sections of the Project Manual.
- B. **PERMITS/FEES.** Work shall not commence until all required building (and/or other) permits have been secured by the Contractor and copies of these permits submitted to the Owner's Representative. Cost of permits is to be included in the Bid Price.

## 4. BID GUARANTY

The bid must be accompanied by a Bid Guaranty which shall not be less than 10% of the amount of the Bid. At the option of the Bidder, the 10% Guaranty may be a Certified Check, Cashier's Check, or a Bid Bond. The Bid Bond shall be secured by a Guaranty or a Surety Company acceptable to the Owner. No bid will be considered unless it is accompanied by the required Guaranty. Funds must be made payable to the order of the Owner. Cash deposits will not be accepted. The Bid Guaranty shall ensure the execution of the Agreement and the furnishing of the Surety Bond or Bonds by the successful Bidder, all as required by the Contract Documents.

## 5. AWARD OF CONTRACT/REJECTION OF BIDS:

The Contracts will be awarded on the basis of Paragraph 5.3 of the Instructions to Bidders and Paragraph 16 of the Supplementary Instructions to Bidders. The Bidders to whom the awards are made will be notified at the earliest possible date. The Owner, however, reserves the right to reject any and all Bids, to accept any combination of base bids and alternates and to waive any technical deficiencies, informalities, or irregularities in Bids received whenever such rejection or waiver is in its interest.

No bid shall be withdrawn for a period of sixty (60) days after the opening of bids without the consent of the Owner. The failure of the Bidder to submit a Bid Bond, Certified Check or Cashier's Check in the full amount to cover all proposals bid upon shall be sufficient cause for rejection of his bid. The award will be made contingent upon submittal and evaluation of Contractor's Qualification Statement, Bonds, Certificate of Insurance, Contractor Certification(s), including Peoria Park District Certificate of Equal Employment Opportunity Compliance for Contractors and Vendors, etc.

## 6. EXECUTION OF AGREEMENT:

Following the award and within ten (10) days after the prescribed forms are prepared and presented for signature by the Owner's Representative, the successful Bidder shall execute and return to the Owner's Representative the Agreement in the form included in the Contract Documents in such number of copies as the Owner may require. The Owner's Representative will provide Notice to Proceed after all bonds and any other required documents have been received by the Park District.

## 7. PERFORMANCE BOND/LABOR AND MATERIAL PAYMENT BOND & INSURANCE

- A. **BONDS REQUIRED.** Having satisfied all conditions of award as set forth elsewhere in these Documents, the successful Bidder shall, within ten (10) calendar days after award of contract, furnish Surety Bonds in penal sums, each not less than the amount of the Contract

as awarded as security for the faithful performance of the Contract (Performance Bond), and for the payment (Labor and Materials Payment Bond) of all persons, firms or corporations to whom the Contractor may become legally indebted for labor, materials, tools, equipment or services employed or used by him in performing the work.

- B. FORM OF BONDS.** Such bonds shall be in the same form as the samples included in the Project Manual and shall bear the same date as or a date subsequent to that of the Agreement. The current Power of Attorney for the person who signs for any Surety Company shall be attached to such Bonds. Bonds shall be signed by a Guaranty or Surety Company acceptable to the Owner.
- C. COST OF PERFORMANCE BOND/LABOR AND MATERIAL PAYMENT BOND.** All costs for the Performance Bond/Labor and Material Payment Bond shall be included in the submitted Bid Price.
- D. INSURANCE.** Insurance requirements for this project are addressed both in the Supplementary General Conditions and in "Attachment A.6", in the "Exhibits" section of this Project Manual.
  - a) In respect to the property ("builders risk") insurance coverages referenced in the Supplementary General Conditions: the successful Bidder will be required to provide such coverages as the work of the Project will be accomplished by one general/prime contractor(s).
- E. TIME FRAMES.** The successful Bidder shall, within ten (10) days after award of contract by the Board of Trustees, submit Proof of Insurance coverages/Bonds in the form and amounts required to the Owner's Representative. Should the Bidder be unable to provide the required Proof of Insurance(s)/Bonds within the specified ten day period the Owner reserves the right, at its sole discretion, to withdraw its award of contract from that Bidder.

#### **8. DEFAULT**

- A.** The failure of the successful Bidders to execute the Agreement, supply the required Bonds or proof of required insurance coverage(s) within (ten) 10 days after award of contract, or within such extended period as the Owner may grant based upon reasons determined sufficient by the Owner, may constitute a default. In such case, award of contract will be transferred to the second lowest bidder.

#### **9. CONTRACTOR'S QUALIFICATION STATEMENT**

- A.** Contractor's Qualification Statement (AIA Document 305) shall be submitted by low bidder for evaluation prior to award of contract if so requested by the Owner or his representatives.

#### **10. LIST OF SUBCONTRACTORS/PRODUCT & EQUIPMENT SUBSTITUTIONS**

- A.** Each Bidder shall submit a "MAJOR SUBCONTRACTORS LIST" proposed to be used in the execution of the Work. If there will be no subcontractors, the Bidder shall state "No Subcontractors" on this form. The completed form is due with the Bid Proposal.
  - 1) Identify the trade name, address, telephone number, and category of work of each subcontractor.
  - 2) Failure to submit the "Major Subcontractors List" with the Bid Proposal may result in the rejection of the Bid.
  - 3) Delete Subparagraphs (6.3.1.1) and (6.3.1.2) from AIA A701.
- B.** The Bidder, by submission of a signed bid form, agrees to install all products and equipment by brand name or names specified in the Technical Specifications sections of this Project Manual. "Or equal" substitutions will be allowed only if approved in writing prior to the bid opening and listed in the "Substitutions" section of the Bid Form.

#### **11. CONTRACT ADMINISTRATION FORMS/COSTS OF FORMS**

- A. REQUIRED FORMS.** The following AIA forms will be used (AIA forms will be supplied by the Owner if requested, and charged to the Contractor at cost) in the administration of the project:
  - 1) **AIA Document A310:** "Bid Bond", February 1970 edition
  - 2) **AIA Document A305:** "Contractor's Qualification Statement", 1986 edition
  - 3) **AIA Document G702:** "Application and Certificate of Payment", May 1992 edition
  - 4) **AIA Document G703:** "Continuation Sheet", May 1992 edition
- B. OTHER FORMS.** Other contract administration forms (to be provided by the Owner unless otherwise noted) required for use in the Project are:
  - 1) **Major Subcontractors List**
  - 2) **Contractor's Affidavit**
  - 3) **Performance Bond**
  - 4) **Labor and Material Payment Bond**
  - 5) **Lien Waiver Forms**

- 6) **Weekly Workforce Report**
- 7) **Certified Payroll Form** (Contractor may use own form)
- 8) **Insurance Forms: As required in Attachment A (at end of Project Manual)** (will not be provided by Owner)
- 9) **Agreement Between Owner and Contractor**

Examples of these forms are included in the Project Manual.

**12. CONSTRUCTION TIME AND LIQUIDATED DAMAGES CLAUSE:**

**PROJECT COMPLETION.** The Agreement will include the following paragraph(s) or language substantially the same, regarding construction time and liquidated damages:

- 1) **LIQUIDATED DAMAGES:** Owner and Contractor recognize that time is of the essence of this Agreement and that Owner will suffer financial loss if the Work is not Substantially Complete within the time specified below, plus any extensions thereof allowed in accordance with Article 8 of the General Conditions. They also recognize the delays, expense and difficulties involved in proving in a legal or arbitration proceeding the actual loss suffered by Owner if the Work is not completed on time.
- 2) Accordingly, instead of requiring any such proof, Owner and Contractor agree that as Liquidated Damages for delay (but not as a penalty) Contractor shall pay Owner TWO HUNDRED AND FIFTY DOLLARS (\$250.00) for each calendar day that expires after seventy-nine (79) calendar days from Notice of Award until Substantial Completion is attained. The work is tentatively scheduled to begin on June 11, 2020 and be at Substantial Completion by August 28, 2020.
- 3) After Substantial Completion, if Contractor shall neglect, refuse, or fail to complete the remaining Work necessary to achieve Final Completion within ten (10) calendar days or any proper extension thereof granted by Owner, Contractor shall pay Owner TWO HUNDRED AND FIFTY DOLLARS (\$250.00) dollars for each day that expires after the time specified.
- 4) Owner and Contractor agree that the per day liquidated damage amounts set forth in subparagraphs "2" and "3" of this section constitute a reasonable forecast of the financial losses, actual costs and increased expenses the Owner may incur as a result of delayed Substantial or Final Completion of the Project.

**13. PROJECT MANUAL/PLANS & SITE VISITATION**

- A. A set of Bid Documents may be examined, at no charge, at the office of the Owner's Representative.
- B. **PLAN DEPOSIT.** An electronic file including Bid Documents is available at [www.peoriaparks-planning.org](http://www.peoriaparks-planning.org) at no charge. A printed set of Bid Documents, including Plans, Specifications and Interpretations for this project may be obtained at the Planning, Design & Construction Department, Bradley Park Equipment Service, 1314 N. Park Road, Peoria, IL 61604. Telephone (309)686-3386. A non-refundable plan deposit of Thirty-Five dollars (\$35.00) will be charged for each printed set of Bid Documents.
- C. **FAMILIARITY WITH BID DOCUMENTS & SITE VISITATION.** Bidders, by submission of their Bids, represent that they have visited the site to acquaint themselves with the local conditions in which the Work is to occur, and that they are familiar with all the requirements of the Project, as defined in the Project Manual and the Plan(s).

**14. OTHER MODIFICATIONS TO AIA-701/OTHER CONDITIONS**

- A. Add the following sentence to (4.1.7): "Bidder shall submit two (2) completed copies of Bid Form and retain one (1) copy for his files."
- B. Delete Section (6.2) - "Owner's Financial Capability"; and last sentence of Paragraph (4.2.1.)
- C. In reference to (7.2.1), the Peoria Park District reserves the right of final approval of bonding companies.
- D. Delete paragraph (7.1.3).

**15. EQUAL EMPLOYMENT OPPORTUNITY/SEXUAL HARASSMENT**

- A. It is a goal of the Peoria Park District to encourage 12% participation of minorities and women on Peoria Park District construction projects through contracts and workforce. Good Faith Effort must be made to encourage the use of minority and women owned businesses as sub-contractors and suppliers on the project. Good Faith Effort is defined below:

Based on the trades and availability of contractors required to complete the project, a minimum of three minority/women owned firms must be contacted. The Park District's list of minority/women owned firms will be included in all bid documents.

The bidder shall negotiate in good faith with the potential minority/women owned firms by not imposing any conditions which are not similarly imposed on all other subcontractors and suppliers, or by denying benefits ordinarily conferred on

subcontractors or suppliers for the type of work for which bids were solicited. Minority and women owned businesses must be notified at least 3 business days prior to bid opening to allow adequate time to review and provide bid.

On all bids over \$100,000.00, the bidder must complete and include in the bid, the **Minority/Women Owned Contact Sheet** form. This form will include name of companies contacted, the time and date companies were contacted, the method by which the companies were contacted, the response by the companies contacted, the area of work the companies were contacted about, and bid amounts received from the companies along with other comments.

The low bidder shall provide to the Park District upon request, copies of all correspondence including without limitation, faxes, letters, text messages, and emails sent to minority/women owned firms.

If a bidder does not provide the required documentation for Good Faith Effort, the bidder may be considered non-responsive and not a responsible bidder on this project. Park District staff may disqualify the bidder and move to the next low bidder.

Failure to complete and submit the following forms (provided in the bid packet) with the Bid may result in rejection of the bid.

- 1) **“Peoria Park District Certificate of Equal Employment Opportunity Compliance for Contractors and Vendors”** Form
- 2) **“Workforce Profile”** Form
- 3) **“Minority/Women Owned Contact Sheet”** Form

**B.** Effective July 1, 1993, every party to a public contract and every party bidding on public contracts is required to have a written **"Sexual Harassment Policy"**. A copy shall be submitted with the Bid. The Sexual Harassment Policy must contain:

- 1) A definition of sexual harassment under state law;
- 2) A description of sexual harassment utilizing examples;
- 3) A formalized complaint procedure;
- 4) A statement of victim's rights;
- 5) Directions on how to contact the Illinois Department of Human Rights - **Illinois companies**. Out-of-State companies must include directions on how to contact the enforcement agency within their state. Companies that issue a standard policy for all business locations must prepare an addendum providing directions on how to contact the appropriate enforcement agency.
- 6) A recitation that there cannot be any retaliation against employees who elect to file charges.

Recommendation: Your **"Sexual Harassment Policy"** should be drafted in language easy to understand and any revisions should be reviewed by legal counsel. A copy of your policy should be posted in a prominent and accessible location to assure all employees will be notified of the company's position.

**In order to conduct business with the Peoria Park District, you must have a written "Sexual Harassment Policy" that conforms to the new Act.**

**FAILURE TO DO SO WILL DISQUALIFY YOU AS AN ELIGIBLE VENDOR.**

## **16. BID SUBMISSION**

**A. DATE, TIME & PLACE OF RECEIVING BIDS.** Bids will be received until the date and time listed in the "Advertisement for Bids", at which time they will be publicly opened, read aloud and recorded. The Bid Opening will be held at the place listed in the "Advertisement for Bids".

**B. REQUIRED ITEMS.** The following items must be included as part of the "BID":

- 1) Two (2) signed copies of the **BID FORM**. (Retain the third copy for your files.)
- 2) The **PEORIA PARK DISTRICT CERTIFICATE OF EQUAL EMPLOYMENT OPPORTUNITY COMPLIANCE FOR CONTRACTORS AND VENDORS** form.
- 3) The **WORKFORCE PROFILE** form.
- 4) The Bidder's **SEXUAL HARASSMENT POLICY**.
- 5) If the bid is over \$100,000.00, the **MINORITY/WOMEN OWNED CONTACT SHEET** form.
- 6) The **CERTIFICATION OF COMPLIANCE OF THE LISTED PROVISIONS AND LAWS** form.



- 7) The **LIST OF SUBCONTRACTORS**. (Submit form and state "No Subcontractors" on the form, if none will be used.)
  - 8) The **BID GUARANTY**.
- C. **BID SUBMISSION**. The "BID" shall be enclosed in envelopes (outer and inner), both of which shall be sealed and clearly labeled with the following information, in order to prevent premature opening of the bid:

- "PROPOSAL"
- NAME OF PROJECT
- NAME OF BIDDER
- DATE/TIME OF BID OPENING

END OF SUPPLEMENTARY INSTRUCTIONS TO BIDDERS

Bid From: \_\_\_\_\_

PROJECT NO. 20-003  
BID FOR: CURB & GUTTER IMPROVEMENTS  
NORTH/UPPER  
LOCATION: BRADLEY PARK

**BID FORM**

BID TO: PEORIA PARK DISTRICT

UNDERSIGNED:

1. Acknowledges receipt of:
  - A. Project Manual and Drawings for:  
\_\_\_\_\_
  - B. Addenda: No. \_\_\_\_\_ through No. \_\_\_\_\_
2. Has examined facility and the bid documents and shall be responsible for performing work specifically required of him by all parts of bidding documents including specifications for entire project, even though such work may be included as related requirements specified in other divisions or sections.
3. And agrees to enter into and execute Contract with Owner, if awarded on basis of this bid, and to:
  - A. Furnish Bonds and Insurance required by the Bidding & Contract Documents.
  - B. Accomplish work in accord with Contract.
  - C. Complete work within specified Contract time.
4. **CONTRACT TIME:** Contractor agrees to Substantially Complete ALL WORK as required by the Contract Documents per the Supplementary General Conditions and Supplementary Instructions to Bidders.
5. **BASE BIDS:**
  - A. Base Bid:  
Bidder agrees to perform all building and site work, as set forth in the Project Manual and Drawings for the sum of:  
  
\_\_\_\_\_ Dollars (\$ \_\_\_\_\_ . \_\_\_\_\_)
6. **ALTERNATES:**  
Bidder agrees to perform all building and/or site work items as set forth below. The prices submitted may be accepted either at the time of Base Bid approval or up to no later than ninety (90) days after award of the Bid; however, if not approved at the time of the award of the Base Bid, the contract times as set forth in the Project Manual and Drawings will be adjusted to compensate for the additional time taken in award of the Alternate:

Bid From: \_\_\_\_\_

PROJECT NO. 20-003  
BID FOR: CURB & GUTTER IMPROVEMENTS  
NORTH/UPPER  
LOCATION: BRADLEY PARK

- A. Add Alternate #1:  
Replacement of curb and gutter in areas indicated on plan.  
\_\_\_\_\_ Dollars (\$\_\_\_\_\_.\_\_\_\_)
- B. Add Alternate #2:  
Replacement of curb and gutter in areas indicated on plan.  
\_\_\_\_\_ Dollars (\$\_\_\_\_\_.\_\_\_\_)
- C. Add Alternate #3:  
Replacement of curb and gutter in areas indicated on plan.  
\_\_\_\_\_ Dollars (\$\_\_\_\_\_.\_\_\_\_)
- D. Add Alternate #4:  
Replacement of curb and gutter in areas indicated on plan.  
\_\_\_\_\_ Dollars (\$\_\_\_\_\_.\_\_\_\_)

7. **UNIT PRICES:**

- A. Bidders submitting prices for the Base Bid shall submit Unit Prices for adding or deleting work. Unit Prices shall include all costs, including but not limited to preparation, labor, equipment, and materials necessary for a complete installation.

<u>ITEM</u>	<u>UNIT</u>	<u>UNIT PRICE</u>
Curb and Gutter	L.F.	\$ _____
Asphalt Patch	S.F.	\$ _____

8. **PROPOSED SUBSTITUTION LIST:**

Base Bid(s) and Alternates are understood to include only those product brands, items, and elements which are specified in the Bid Documents. The following is a list of substitute products, equipment or methods of construction which the Bidder proposes to furnish on this project, with difference in price being added or deducted from Base Bid(s).

Bidder understands that acceptance of any proposed substitution which has not been approved as an "equal" to the product brand, item, or element specified prior to bid opening is at Owner's option. Approval or rejection of any substitutions listed below will be indicated before executing Contract.

<u>ITEM</u>	<u>ADD</u>	<u>DEDUCT</u>
_____	\$ _____	\$ _____
_____	\$ _____	\$ _____

Bid From: \_\_\_\_\_

PROJECT NO. 20-003  
BID FOR: CURB & GUTTER IMPROVEMENTS  
NORTH/UPPER  
LOCATION: BRADLEY PARK

\_\_\_\_\_ \$ \_\_\_\_\_ \$ \_\_\_\_\_

9. **BIDDERS CHECKLIST:**

Did you visit the site?	Yes	No
Is Bid Security enclosed? (If applicable)	Yes	No
Is Peoria Park District Certificate of Equal Employment Opportunity Compliance for Contractors enclosed?	Yes	No
Is Workforce Profile enclosed?	Yes	No
Is Bidder's Sexual Harassment Policy enclosed?	Yes	No
If the bid is over \$100,000.00, the Minority/Women Owned Contact Sheet enclosed?	Yes	No
Is List of Subcontractors enclosed?	Yes	No
Is Certification of Compliance of the Listed Provisions and Laws form enclosed?	Yes	No

10. **BIDDER INFORMATION:**

NAME OF BIDDER: \_\_\_\_\_

ADDRESS: \_\_\_\_\_

CITY, STATE, ZIP: \_\_\_\_\_

TELEPHONE NO.: \_\_\_\_\_

BY: \_\_\_\_\_

(Signature of Authorized Official)

TITLE: \_\_\_\_\_

BIDDER'S SEAL

Bid From: \_\_\_\_\_

PROJECT NO. 20-003  
BID FOR: CURB & GUTTER IMPROVEMENTS  
NORTH/UPPER  
LOCATION: BRADLEY PARK

WITNESS: \_\_\_\_\_

END OF BID FORM



**Peoria Park District**  
**Certificate of Equal Employment Opportunity Compliance**  
**for**  
**Contractors and Vendors**

Disclosure of the information requested in this form is required by the Peoria Park District. Failure to properly complete and sign this form will result in it being returned unprocessed thereby resulting in a delay or denial of eligibility to bid.

As part of the Company's commitment to equal employment opportunity practices, this company does the following:

- Recruits, trains, upgrades, promotes and disciplines persons without regard to race, color, sex, religion, national origin, veteran status, age, mental or physical ability.
- Notifies all recruitment sources that all qualified applicants will be considered for employment without regard to race, color, sex, religion, national origin, veteran status, age, mental or physical ability.
- When advertising is used, specifies that all qualified applicants will be considered for employment without regard to race, color, sex, religion, national origin, veteran status, age, mental or physical ability.
- Notifies all labor organizations which furnish this company with any skilled or non-skilled labor of the Company's responsibility to comply with the equal employment opportunity requirements required in all contracts by the Peoria Park District.
- Notifies all of its sub-contractors of their obligation to comply with the equal employment opportunity requirements required in all contracts by the Peoria Park District.
- Has an affirmative action program that assures the company's fair employment practices are understood and carried out by all of its managerial, administrative and supervisory personnel.

Is the Company a minority/woman owned business (MBE/WBE)?  NO  YES, if yes  MBE or  WBE?

The Company does not discriminate against any employees or applicants for employment because of race, color, religion, sex, national origin, veteran status, age, mental or physical ability.

The Company does not maintain segregated facilities for any of its employees on the basis of race, religion, color, national origin, because of habit, local custom, or otherwise.

The Company has a written sexual harassment policy meeting the Illinois Department of Human Rights requirements.

By signing this form, the Company attests that it complies with all statements listed above as part of the Company's commitment to equal employment opportunity practices. The Company further agrees that it has completed the attached Workforce Profile Sheet truthfully, to the best of its knowledge.

\_\_\_\_\_  
Company Name

\_\_\_\_\_  
Company Address

\_\_\_\_\_  
Signature of Company Official

\_\_\_\_\_  
Name / Title

\_\_\_\_\_  
Telephone Number & Fax Number

\_\_\_\_\_  
Email Address

Rev. 9/2017

## WORKFORCE PROFILE

Job Classifications	Black Employees		White Employees		Hispanic Employees		Native American Employees		Asian Employees		Other Employees		TOTAL EMPLOYEES	
	M	F	M	F	M	F	M	F	M	F	M	F	M	F
1. Officials, Managers, Supervisors														
2. Professionals														
3. Technicians														
4. Sales														
5. Office/Clerical														
6. White Collar Trainees:														
7. Skilled Crafts:														
8. Apprentices:														
9. On-the-job Trainees:														
10. Semi-skilled														
11. Service Workers														
12. Unskilled														
TOTALS														

Company Name: \_\_\_\_\_

# WORKFORCE PROFILE INSTRUCTIONS

## RACE/ETHNIC IDENTIFICATION

WHITE (not of Hispanic origin): All persons having origins in any of the original peoples of Europe, North Africa, or the Middle East.

BLACK (not of Hispanic origin): All persons having origins in any of the Black racial groups of Africa.

HISPANIC: All persons of Mexican, Puerto Rican, Cuban, Central or South American, or other Spanish culture or origin, regardless of race.

ASIAN or PACIFIC ISLANDER: All persons having origins in any of the original peoples of the Far East, Southeast Asia, the Indian Subcontinent, or the Pacific Islands. This area includes, for example, China, India, Japan, Korea, the Philippine Islands, and Samoa.

NATIVE AMERICAN or ALASKAN NATIVE: All persons having origins in any of the original peoples of North America, and who maintain cultural identification through tribal affiliation or community recognition.

## DESCRIPTION OF JOB CLASSIFICATIONS

OFFICIALS, MANAGERS, AND SUPERVISORS - Occupations requiring administrative personnel who set broad policies, and exercise over-all responsibility for the execution of these policies, and direct individual departments or special phases of a firm's operations. Includes: officials, executives, middle management, plant managers, department managers/superintendents, salaried foremen who are members of management, purchasing agents and buyers, and kindred workers.

PROFESSIONALS - Occupations requiring either college graduation or experience of such kind and amount as to provide a comparable background. Includes: accountants/auditors, airplane pilots and navigators, architects, artists, chemists, designers, dietitians, editors, engineers, lawyers, librarians, mathematicians, natural scientists, personnel and labor relations workers, physical scientists, physicians, social scientists, teachers, and kindred workers.

TECHNICIANS - Occupations requiring combination of basic scientific knowledge and manual skill which can be obtained through about 2 years of post high school education, such as is offered in many technical institutes and junior colleges, or through equivalent on-the-job training. Includes: drafters, engineering aids, junior engineers, scientific assistants, surveyors, technical illustrators, technicians (medical, dental, electronic physical sciences), and kindred workers.

SALES WORKERS - Occupations engaging wholly or primarily in direct selling. Includes: advertising agents/salespersons, insurance agents/brokers, real estate agents/brokers, stock and bond salespersons, demonstrators, salespersons and sales clerks, and kindred workers.

OFFICE AND CLERICAL WORKERS - Includes all clerical type work regardless of level of difficulty, where the activities are predominantly non-manual though some manual work not directly involved with altering or transporting the products is included. Includes: bookkeepers, cashiers, collectors (bills and accounts), messengers and office couriers, office machine operators, shipping and receiving clerks, stenographers, typist and secretaries, telegraph and telephone operators, and kindred workers.

WHITE COLLAR TRAINEES - Persons engaged in formal training for official, managerial, professional, technical, sales, office and clerical occupations.

SKILLED CRAFTS - Manual worker of relatively high skill level having a thorough and comprehensive knowledge of the processes involved in their work. Exercise considerable independent judgment and usually receive an extensive period of training. Includes: the building trades hourly paid foremen and leadmen who are not members of management, mechanics and repairmen, skilled machining occupations, compositors and typesetters, electricians, engravers, job setters (metal), motion picture projectionists, pattern and model makers, stationary engineers, tailors and tailoresses, and kindred workers.



APPRENTICES - Persons employed in a program including work training and related instruction to learn a trade or craft which is traditionally considered an apprenticeship, regardless of whether the program is registered with a Federal or State agency.

ON-THE-JOB TRAINEES - Persons engaged in formal training for craftsmen when not trained under apprentice programs; semi-skilled, unskilled and service occupations.

SEMI-SKILLED WORKERS - Workers who operate machine or processing equipment or perform other factory-type duties of intermediate skill level which can be mastered in a few weeks and require only limited training.

SERVICE WORKERS - Workers in both protective and non-protective service occupations. Includes: attendants (hospital and other institution, professional and personal service), barbers, charwomen and cleaners, cooks (except household), counter and fountain workers, elevator operators, fire fighters, guards, watchmen and doorkeepers, stewards, janitors, police officers and detectives, porters, waiters and waitresses, and kindred workers.

UNSKILLED WORKERS - Workers in manual occupations which generally require no special training. Perform elementary duties that may be learned in a few days and require the application of little or no independent judgement. Includes: garage laborers, car washers and greasers, gardeners (except farm) and groundskeepers, longshoremen and stevedores, lumbermen, craftsmen and wood choppers, laborers performing lifting, digging, mixing loading and pulling operations, and kindred workers.

# Minority/Women Owned Contact Sheet

## Proof of Contact Efforts by General Contractor of MBE/WBE firms for the project

MBE/WBE Company Name	Minority Owned or Woman Owned?	Individual Contacted at MBE/WBE also date/time	Method of Contact & Information: Phone #, Fax #, Email	Response: (Provided Bid or No Bid?)	Area of Work	Comments: If Bid accepted, give \$ amount. If Bid not accepted, give justification.

Company Name \_\_\_\_\_

## **PLEASE BE ADVISED!**

Every party to a public contract and every party bidding on public contracts are required to have a written sexual harassment policy that contains:

- (1) a definition of sexual harassment under state law;
- (2) a description of sexual harassment utilizing examples;
- (3) a formalized complaint procedure;
- (4) a statement of victims rights;
- (5) directions on how to contact the Illinois Department of Human Rights – **Illinois companies.** **Out-of-State companies must include directions on how to contact the enforcement agency within their state.** Companies that issue a standard policy for all business locations must prepare an addendum providing directions on how to contact the appropriate enforcement agency.
- (6) a recitation that there cannot be any retaliation against employees who elect to file charges.

**Recommendation:** Your sexual harassment policy should be drafted in language easy to understand and any revisions should be reviewed by legal counsel. A copy of your policy should be posted in a prominent and accessible location to assure all employees will be notified of the company's position.

**In order to conduct business with the PEORIA PARK DISTRICT, you must have a written sexual harassment policy that conforms to the new ACT.**

**FAILURE TO DO SO  
WILL DISQUALIFY YOU AS AN ELIGIBLE VENDOR!!!**

*Please be advised, effective July 1, 1993, Governor Jim Edgar established under Executive Order Number 7 (Public Act 87-1257) that every party to a public contract and every party bidding on a public contract within the State of Illinois must have a written policy statement prohibiting sexual harassment. The following model policy statement is a draft copy provided for use in formulating your company's policy statement*

---

---

**SEXUAL HARASSMENT POLICY STATEMENT**

It is the responsibility of each individual employee to refrain from sexual harassment and it is the right of each individual employee to work in an environment free from sexual harassment.

**DEFINITION OF SEXUAL HARASSMENT**

According to the Illinois Human Rights Act, sexual harassment is defined as:

Any unwelcome sexual advances or requests for sexual favors or any conduct of a sexual nature when

1. submission to such conduct is made either explicitly or implicitly a term or condition of an individual's employment;
2. submission to or rejection of such conduct by an individual is used as the basis for employment decision(s) affecting such individual; or
3. such conduct has the purpose or effect of substantially interfering with an individual's work performance or creating an intimidating, hostile, or offensive working environment.

The courts have determined that sexual harassment is a form of discrimination under Title VII of the U.S. Civil Rights act of 1964, as amended in 1991. One such example is a case where a qualified individual is denied employment opportunities and benefits that are, instead, awarded to another individual who submits (voluntarily or under duress) to sexual advances or sexual favors. Another example is where an individual submits to unwelcome sexual conduct in order to receive an employment opportunity.

D R A F T

Other conduct commonly considered to be sexual harassment includes:

- ⇒ Verbal: Sexual innuendoes, suggestive comments, insults, humor and jokes about sex, anatomy or gender-specific traits, sexual propositions, threats, repeated requests for dates, or statement about other employees, even outside of their presence, of a sexual nature.
- ⇒ Non-Verbal: Suggestive or insulting sounds (whistling), leering, obscene gestures, sexually suggestive bodily gestures, "catcalls", "smacking" or "kissing" noises.
- ⇒ Visual: Posters, signs, pin-ups, slogans of a sexual nature.
- ⇒ Physical: Touching, unwelcome hugging or kissing, pinching, brushing the body, coerced sexual intercourse or actual assault.

Sexual harassment most frequently involves a man harassing a woman. However, it can also involve a woman harassing a man or harassment between members of the same gender.

The most severe and overt forms of sexual harassment are easier to determine; however, some sexual harassment is more subtle and depends to some extent on individual perception and interpretation. The trend in the courts is to assess sexual harassment by a standard of what would offend a "reasonable woman" or a "reasonable man", depending upon the gender of the alleged victim.

An example of the most subtle form of sexual harassment is the use of endearments. The use of terms such as "honey", "darling", and "sweetheart" is objectionable to many women who believe that these terms undermine their authority and their ability to deal with men on an equal and professional level.

Another example is the use of a compliment that could potentially be interpreted as sexual in nature. Below are three statements that might be made about the appearance of a woman in the workplace:

Sexual Harassment Model Policy Statement  
Page 2

- ⇒ “That’s an attractive dress you have on.”
- ⇒ “That’s an attractive dress. It really looks good on you.”
- ⇒ “That’s an attractive dress. You really fill it out well.”

The first statement appears to be simply a compliment. The last is most likely to be perceived as sexual harassment depending on individual perceptions and values. To avoid the possibility of offending an employee, it is best to follow a course of conduct above reproach, or to err on the side of caution.

**RESPONSIBILITY OF INDIVIDUAL EMPLOYEES**

Each individual employee has the responsibility to refrain from sexual harassment in the workplace. An individual employee who harasses a fellow worker is, of course, liable for his or her individual conduct. The harassing employee will be subject to disciplinary action up to and including discharge in accordance with company/organization policy or a collective bargaining agreement, as appropriate.

**RESPONSIBILITY OF SUPERVISORY PERSONNEL**

Each supervisor is responsible for maintaining a workplace free of sexual harassment. This is accomplished by promoting a professional environment and by dealing with sexual harassment as with all other forms of employee misconduct.

The courts have found companies/organizations as well as supervisors can be held liable for damages related to sexual harassment by a manager, supervisor, employee, or third party (an individual who is not an employee but does business with a company/organization, such as a contractor, customer, sales representative, or repair person).

Liability is based either on a company/organization's responsibility to maintain a certain level of order and discipline, or on the supervisor acting as an agent of the company/organization. As such, supervisors must act quickly and responsibly, not only to minimize their own liability, but also that the company/organization.

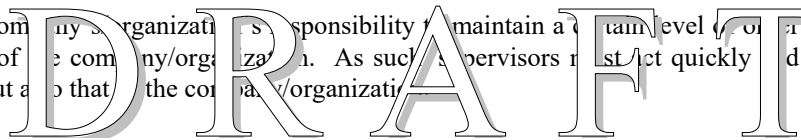

**RESOLUTION OUTSIDE THE COMPANY/ORGANIZATION**

It is hoped that most sexual harassment complaints and incidents can be resolved within a company/organization. However, an employee has the right to contact the Illinois Department of Human Rights (IDHR) or the U.S. Equal Employment Opportunity Commission (EEOC) about filing a formal complaint. An IDHR complaint must be filed within 180 days of the alleged incident(s) unless it is a continuing offense. A complaint with EEOC must be filed within 300 days.

***Illinois Department of Human Rights***  
(217) 785-5100 – Springfield  
(217) 785-5125 – TDD Springfield  
(312) 814-6200 – Chicago  
(312) 263-1579 – TDD Chicago

***Illinois Human Rights Commission***  
(217) 785-4350 – Springfield  
(217) 785-5125 – TDD Springfield  
(312) 814-6269 – Chicago  
(312) 814-4760 – TDD Chicago

***U.S. Equal Employment Opportunity Commission***  
(312) 353-2613 – Chicago District Office  
(800) 669-4000 – Toll Free Within State of Illinois  
(800) 669-6820 – TDD Chicago

An employee who is suddenly transferred to a lower paying job or passed for promotion, after filing a complaint with IDHR or EEOC, may file a retaliation charge, also due 180 days (IDHR) or 300 days (EEOC) from the alleged retaliation.

An employee who has been physically harassed or threatened while on the job may also have grounds for criminal charges of assault and battery.

**FALSE AND FRIVOLOUS COMPLAINTS**

False and frivolous charges refer to cases where the accuser is using a sexual complaint to accomplish some end other than stopping sexual harassment. It does not refer to charges made in good faith which cannot be proven. Given the seriousness of the consequences for the accused, a false and frivolous charge is a severe offense that can itself result in disciplinary action.

**CERTIFICATION OF COMPLIANCE  
OF THE LISTED PROVISIONS AND LAWS**

**1) Illinois Drug Free Workplace Act of 1991**

**2) The Substance Abuse Prevention on Public Works Act Public Act 95-0635:**

Prohibits the use of drugs and alcohol while performing work on a public works project.

The Contractor/Subcontractor has signed collective bargaining agreement for all of its employees that deal with the subject matter or the Contractor/Subcontractor has a prevention program that meets or exceeds the requirements of the Public Act for all employees not covered by a collective bargaining agreement.

**3) Safety Compliance:**

Contractor/Subcontractors will comply with any and all prevailing occupational safety and health standards. Such compliance may include a training component or require a written program of compliance.

**4) Illinois Criminal Code, Illinois Compiled Statutes 720 ILCS 5/33E-3 and 5/33E-4:**

Contractor/Subcontractor has not been barred from bidding on public contract as a result of bid rigging or bid rotating.

The undersigned representative of the Contractor/Vendor hereby certifies to comply with the laws and provisions listed above.

\_\_\_\_\_  
Contractor/Subcontractor

\_\_\_\_\_  
Name of Authorized Representative (type or print)

\_\_\_\_\_  
Signature of Authorized Representative

\_\_\_\_\_  
Date

**MAJOR SUBCONTRACTORS LIST**

The following tabulation of Major Subcontractors shall be attached and made a condition of the Bid. The Bidder expressly understands and agrees to the following provisions:

- A. If awarded a Contract as a result of this Bid, the major subcontractors used in the prosecution of the work will be those listed below.
- B. The following list includes all subcontractors who will perform work representing 5% (five percent) or more of the total Base Bid.
- C. The subcontractors listed below are financially responsible and are qualified to perform the work required.
- D. The subcontractors listed below comply with the requirements of the Contract Documents.
- E. Any substitutions in the subcontractors listed below shall be requested in writing by the Contractor and must be approved in writing by the Owner. No sub-subcontractors will be allowed unless specifically stated on the form. All pertinent financial, performance, insurance and other applicable information shall be submitted with the request for substitution(s). Owner shall respond to such requests within 14 calendar days following the submission of all necessary information to the full satisfaction of the Owner.
- F. Failure to submit the list of Major Subcontractors as stated herein shall constitute a material variation from the Invitation to Bid; and any such Bid may be rejected by the Owner.

Subcontractor Name	Address	Telephone	Area of Work	Minority/Women Owned Business (Yes/No)

(Attach additional sheets if required)

BIDDER: \_\_\_\_\_

END OF MAJOR SUBCONTRACTORS FORM

# Directory of Minority & Women Owned Business Enterprises Peoria Park District

Revised 11/2019

---

<b>Absolute Risk Management Strategies</b> Kelly Peterson	MBE Construction Safety, Job Site Safety Plan Development, Job Site Risk Assessment, Construction OSHA Training 416 Main St., Suite 533, Peoria, IL 61602	309-256-8471 309-222-4050 Cell
<b>Adams Septic &amp; Sewer Services, Inc.</b> Michelle Adams	WBE Septic and Sewer Contractor 1641 N. Tiber Ridge Ct., East Peoria, IL 61611	309-691-6113
<b>Aerial Work Services Company</b>	MBE Landscaping and Seeding 13805 Wadsworth Road, Wadsworth, IL	847-662-5321 847-662-5321 Fax
<b>AFE Construction, Inc.</b> Tommy and Monica Arbuckle	WBE General Contractor WBE P.O. Box 199, Mackinaw, IL 61755	309-303-7065 866- 491-2209 Fax Tommy.afeinc@hotmail.com
<b>A &amp; L Salvage, Inc.</b> Archie Brown	MBE Clean Up, Tree Cutting & Removal, Truck Salvaging 824 W. Brons Peoria, IL 61604	309-682-4412
<b>Alexander Brothers Construction Co.</b> Allester Alexander	MBE Concrete, Demolition, Excavation, Landscaping P.O. Box 1508, Peoria, IL 61605	309-673-6768 <a href="mailto:abrosconst@aol.com">abrosconst@aol.com</a>
<b>Alexander &amp; Sons Construction</b> Leonard Alexander	MBE Driveways, Curbs, Foundations, Layouts, Sidewalks, etc. 2415 N. Linn Street, Peoria, IL 61604 <a href="mailto:Leonardalexander1467@yahoo.com">Leonardalexander1467@yahoo.com</a>	309-678-3004 773-628-9064 (cell)
<b>Allworld Project Management LLC</b> Ronnie Foster Jr.	MBE Highway, Street & Bridge Construction, Water & Sewer Line and Related Construction, Landscaping, Civil Engineering 415 South Front Street, Suite 121, Memphis, TN 38103 <a href="mailto:procurement@allworldmail.com">procurement@allworldmail.com</a>	901-881-2985
<b>A. Lucas &amp; Sons Steel</b> Margaret Hanley 309-673-7213 Fax	WBE Structural Steel Fabrication	309-673-8547 1328 SW Washington, Peoria, IL 61602  Margaret@alucasiron.com
<b>Ambri Inc.</b> Robert J. Hunt. Jr.	MBE Drywall, Flooring, Painting, Cabinetry 9101 S. Nashville Ave., Oak Lawn, IL 60453	708-233-0217 Ph/ Fax
<b>A Unique Maintenance Service</b> Andrea McKnight	MBE Commercial and Industrial Construction Cleanup 1215 N. Sheridan Road, Suite A, Peoria, IL 61606	309-637-4400 309-637-1300 Fax 309-453-3393 Cell
<b>BMI Contractors &amp; Assoc.</b> Sammy Hobson	MBE Excavation, Concrete 1123 MacQueen., Peoria, IL 61604 <a href="mailto:bmicontractorsandassociates@comcast.net">bmicontractorsandassociates@comcast.net</a>	309-657-4469 Ph 309-713-1569 Fax
<b>Braun Excavating, Inc.</b> Teresa Braun	WBE Demolition, Digging of Footings, Excavation, Pipe Laying 24 Gulf Stream, Bartonville, IL 61607	309-697-5454 309-697-6567 Fax
<b>Brown, Leo Trucking, Inc.</b> Leo Brown	MBE Trucking/Hauling P. O. Box 9057, Peoria, IL 61612	309-685-6710 309-685-0759 Fax
<b>Buddy's Landscaping</b> Dexter Davis	MBE Landscaping P. O. Box 1836, Bloomington, IL 61702	309-824-9211 309-454-3342 Fax <a href="mailto:Dexterdavis2@aol.com">Dexterdavis2@aol.com</a>
<b>Burnside Brothers Construction</b> Terry Burnside	MBE Landscaping, General Construction 3563 SW Adams, Peoria, IL 61605	309-922-9390
<b>C and G Concrete Construction Co. Inc.</b> Patricia Slusher	WBE Concrete <a href="mailto:bruce@cngconcrete.com">bruce@cngconcrete.com</a>	309-699-0384 309-699-6922 Fax

CURB & GUTTER IMPROVEMENTS NORTH/UPPER –BRADLEY PARK - Project Manual



		309-208-2646 Cell
<b>Capitol Trucking</b> Eddie Washington	MBE Trucking, Snow Removal 2803 Creston Lane, Peoria, IL 61604	309-339-5313
<b>Central IL Construction Inc.</b> Jessica Youngman	WBE Land Surveying 416 Germantown Rd., Germantown, IL 61548	309-383-3156
<b>Central IL Consulting</b> Jessica Youngman	WBE Land Surveying 416 Germantown Rd., Germantown, IL 61548	309-383-3156 youngman@mtco.com
<b>Central IL Rebar Insulators</b> Roger Fleming	MBE Structural Steel and Rebar Replacement 4719 Ridgelawn Place, Peoria, IL 61615	309-258-1379 888-387-5716 Fax 309-258-1379 Cell
<b>Central Landscaping</b> Donna Brandenburg	WBE Seeding, Landscaping 12512 Mendell Rd., Princeville, IL 61559	309-385-4832 309-385-2644 Fax
<b>CJL Landscaping, Inc.</b> Rebecca J. Kelch	WBE Landscaping 10902 W. U. S. Highway 150, Brimfield, IL 61517	309-691-9200 309-691-5131 Fax <a href="mailto:Meinders_81@yahoo.com">Meinders_81@yahoo.com</a> <a href="mailto:jrdoering@att.net">jrdoering@att.net</a>
<b>Clevenger Contractors Inc.</b> Verlee Clevenger Misty L. Daham	WBE Guardrail, Bridge Rail, Seeding, Fencing 355 Naples Rd., P.O. Box 19, Bluffs, IL 62621	217-754-3411 217-754-3537 Fax clever@irtc.net
<b>CNS Forestry &amp; Landscaping LLC</b> Christine Schilling	WBE Landscaping, Seeding, Sodding, Tree Removal 1813 1000 <sup>th</sup> St., Lincoln, IL 62656	217-792-3808 217-792-3808 Fax
<b>Concrete to Perfection</b> Elonda Whitfield	WBE/MBE Designs on Concrete concretetoperfection@gmail.com	309-681-9508
<b>Cordova Construction</b> Tina Christopher 309-208-3448 Cell	WBE Concrete Removal, Curb & Gutter Removal, Sidewalk Removal	309-674-8810 2424 N. Ellory Road, Peoria, IL 61615
<b>Cornerstone Builders &amp; Developers</b> Ron Touilly	WBE 6129 W. Southport Rd., Peoria, IL 61615	309-674-9000 309-673-7783 Fax
<b>Creative Touch Painting</b> Chris Ridge	MBE Painting Exterior/Interior 3318 N. Isabell Ave., Peoria, IL 61604	309-229-1253 309-643-7400 Cell info@creativetouchpnt.com
<b>CSS (Construction Specialties &amp; Services)</b> Dave Suzuki	MBE Building Specialties, Design, Engineering, Estimating P. O. Box 120703 Peoria, IL 61614	309-685-8453
<b>CWG Inc.</b> Teresa Gustafson	WBE Demolition, Excavation, Trucking 24635 Cooper Rd., Morton, IL 61550	309-208-5461 Cell 309-208-8899 Cell tgusdesigns@yahoo.com
<b>Davis Brothers Construction Company</b> Russell Davis	MBE Trucking/Hauling 1522 W. Kettelle St. Peoria, IL 61605	309-683-6931
<b>DECA Realty</b> Eddie J. Washington	MBE Real Estate Broker, Appraiser 417 W. Main, Peoria, IL 61606	309-637-3322 309-682-3922 Fax
<b>Design Air Inc.</b> Courtney Eston	MBE Commercial Air Duct Cleaning 3806 W. Hearthwood Dr., Dunlap, IL 61525	309-693-8632 309-243-2102 Fax
<b>Dunbar Transfer</b>	WBE Trucking P.O. Box 315, Chillicothe, IL 61523-0315	309-303-5122
<b>E &amp; D Trucking and Hauling, Inc.</b> Eddie Proctor	MBE Trucking/Hauling 1913 N. Idaho, Peoria, IL 61604	309-682-4336 309-251-6736 Cell
<b>E. Davis Trucking Company</b> Eric Davis	MBE Trucking edavistrucking@gmail.com	309-648-1450

<b>Earth Care Unlimited, Inc.</b> Monica Thornley	WBE Landscaping, Seeding, Sodding 3108 Panther Grove Rd, Ashland, IL 62612	217-452-7370 217-414-4321
<b>Fire &amp; Ice Heating and Air</b> J.T. Toombs	MBE HVAC Maintenance, Installment 922 W. Smith St., Peoria, IL 61605	309-219-3708
<b>Foster-Jacob Electric</b> Emily Rudesill	WBE Electrical 826 W. Main St., Peoria, IL 61606	309-674-8129
<b>Fuhrmann Engineering Inc.</b> Kathy Shelter	WBE Civil Engineers / Land Surveyors 456 Fulton St., Suite 146	309-713-3498 Ext. 5
<b>Flessner Electric</b>	WBE Electrical 3600 S. Cameron Ln., Mapleton, IL 61547	309-697-2484
<b>Foster-Jacob Electric</b> Emily Rudesill	WBE Electrical 826 W. Main St., Peoria, IL 61606	309-674-8129 309-674-6890 Fax emilyj@fosterjacob.com
<b>Garza Heating &amp; Cooling</b>	MBE HVAC 1304 S. Western Ave., Peoria, IL 61605	309-645-6294
<b>Get Current Electrical Serv.</b> Richard Rhodes	MBE Electrical 4210 N. Northbrook Ct. Richard_rhodes2001@yahoo.com	309-989-7931
<b>Ronald A. Givens &amp; Associates</b> Ronald A. Givens	MBE Insurance & Investments 2616 N. Lehman, Peoria, IL 61602	309-685-4588 309-676-3152 Fax
<b>GIVSCO Construction</b> Ronald Givens	MBE General Contractor 2321 Lakeshore Dr., Pekin, IL 61554	309-620-9127 info@givSCO.com
<b>Gutters &amp; More</b>	WBE 157 Thunderbird Ln., East Peoria, IL 61611	309-694-4000 309-694-3356 Fax
<b>Hancock Trucking, Inc.</b> Nancy Hancock	WBE Trucking/Hauling 30570 Hancock Road Mackinaw, IL 61755	309-447-6733
<b>Hanley Steel, Inc.</b> Jill Hanley	WBE Fabricated Structural and Miscellaneous Steel 8811 N. Industrial Rd., Peoria, IL 61615	309-692-5250 309-692-5251 Fax
<b>Heart Technologies</b> Jim Bainter, Brad Armstrong	WBE Data and Telephone, Communication and Construction 3105 N. Main Street, Peoria, IL 61611	309-427-7000 309-427-7007 Fax
<b>Hermann &amp; Associates</b> Alisha Hermann	WBE Consultant Engineering 5835 N. Galena Rd., Peoria, IL 61614	309-687-5566 309-687-0571 Fax
<b>Horan Construction, Inc.</b> Susan Arnholt	WBE Carpentry, Concrete, Demolition, General, Wrecking 1720 W. Chanute Road Peoria, IL 61615	309-691-3133 309-691-1841 Fax
<b>Illinois Mechanical Service &amp; Design</b> Beth Ward	WBE HVAC P.O. Box 10494, Peoria, IL 61612	309-713-3640 309-274-6941
<b>Infrastructure Engineering</b> Thu Truitt	MBE Civil Engineering 456 Fulton St., Suite 104, Peoria, IL 61602	309-637-9200 309-637-9210
<b>Intech Innovations</b> John McCrary	WBE Audio/Video Design and Integration Washington, IL 61571	309-370-6676 309-745-9691 Fax
<b>Interlock Brick Paving</b> Chris Joos	WBE Hardscaping, Landscaping, Excavating P.O. Box 6, Morton, IL 61550 chris@interlockbrickpaving.com	309-696-9264
<b>JC Construction</b> Frank Coates	MBE General 1810 Stever, Peoria, IL 61605	309-303-3919 Cell
<b>JAKS Construction Inc</b> John Spencer	Disabled Vet Full Service Concrete Cutting, Drilling & Sealing 19319 Great Crane Road, Bloomington, IL 61705	800-455-9662 309-455-9662 Fax 309-846-6382 Cell jaksinc@live.com

<b>J &amp; K Construction</b> James Tillman	MBE General 4003 N. Rochelle, Peoria, IL 61615	309-685-8554 309-685-8554 Fax 309-264-3903 Cell <a href="mailto:j&amp;kconst@comcast.net">j&amp;kconst@comcast.net</a>
<b>J &amp; J Construction</b> Herman Johnson	MBE Concrete Removal, Curb & Gutter Removal, Demolition 1300 W. Aiken Avenue, Peoria, IL 61605	309-657-9228 309-676-8292 Fax 309-657-9228 Cell
<b>JM Industrial Supply</b> Ron Given	MBE Maintenance Items, Tools, Soaps 2323 Lakeshore, Pekin, IL 61554	309-346-5796 309-347-5100 Fax
<b>Kahbeah Contracting &amp; Trucking</b> Larry Kahbeah	MBE Trucking/Hauling 510 N. Yates, P. O. Box 56, Tallula, IL 62688	217-634-4157 217-634-4157 Fax
<b>Kerry Brown Trucking</b> Leo K. Brown	MBE Tandem, Semi Dump, General Hauling Peoria, IL	309-251-6089 Cell leok.brown1957@gmail.com
<b>Kreiling Roofing Co.</b>	WBE Slate, Wood Shakes, Tile, Thatch, Custom Fabricated Copper and Steel, Residential and Commercial 2335 W. Altorfer Dr., Peoria, IL 61615	309-673-3649 309-692-2504 Fax 309-397-7747 Cell <a href="mailto:lmoore@kreiling.com">lmoore@kreiling.com</a>
<b>Leo Brown Trucking Inc</b> Leo Brown	MBE Trucking PO Box 9057, Peoria, IL 61612	309-685-6710 309-685-0759 Fax 309-303-7111 Cell
<b>LIZZ Trucking &amp; Hauling</b> Brandon Hines	MBE Trucking/Hauling lizztrucking@yahoo.com	309-208-5942
<b>LNR Construction &amp; Trucking</b> Demonte Davis Lavael Randle Sr.	MBE Concrete, Trucking 2200 N. Linsley St., Peoria, IL 61605	309-682-6331 309-682-6331 Fax 309-678-3314 Cell
<b>LV Enterprise</b> John L. Palmer	MBE Trucking/Hauling 303 E. Archer Avenue, Peoria, IL 61603	309-657-2420 309-682-8872 Fax
<b>M &amp; A Plumbing</b> Michael Abner	MBE Plumbing 6216 N. Devonshire Avenue, Peoria, IL 61615	309-689-0133 309-689-0133 Fax
<b>M&amp;K Heating &amp; Cooling</b> Reggie Williams	MBE HVAC 2406 W. Newman Parkway, Peoria, IL 61604	309-256-6129
<b>M &amp; L Plumbing</b> Manzell Lawson	MBE Plumbing 1309 W. Lincoln, Peoria, IL 61605	309-674-8466
<b>McGinnis Transportation</b> Beth McGinnis	WBE Trucking, Tandem, 24" Box Truck 336 Riverview Drive, Creve Coeur, IL 61610	309-369-4465 309-694-1604 Fax
<b>Michlyn Corporation</b> Fred Danage	MBE Concrete, Landscaping, Lead Based Paint Abatement P.O. Box 5895, Peoria, IL 61601	309-829-2115 309-303-1561 Cell <a href="mailto:macdanage@yahoo.com">macdanage@yahoo.com</a>
<b>Mid-Illinois Companies, Corp.</b> Debra Young	WBE Metal Framing, Insulation, Drywall, Plaster and Exterior Insulation, Acoustical Ceilings and Wall Panels, Painting and Wall Covering, Access Flooring 905 NE Adams St., Peoria, IL 61603	309-674-0717 309-674-5802 Fax dyoung@mic123.com
<b>Midwest Construction Services</b> Sheila Shover	M/WBE Traffic Control Products, Trucking/Hauling P. O. Box 4185, Bartonville, IL 61607	309-697-1000 309-697-1004 Fax
<b>Millennia Professional Services of IL</b> Paul Moreno	MBE Civil Engineering, Erosion Control, Landscaping, Sewer Construction, Surveying, Retaining Walls 850 N. Main St., Morton, IL 61550	309-321-8141 309-321-8142 Fax 309-303-8428 Cell pmoreno@mps-il.com
<b>Molleck Electric</b>	WBE Electrical 14926 W. Winchester Dr., Brimfield, IL 61517	309-446-3483

<b>N.E. Rudd Trucking</b> Nanette E Jenkins-Rudd	WBE Excavating, Hauling, Asphalt, Dirt, Gravel, Sand Milling ; Dumps and Tandems PO Box 14, Kingston Mines, IL 61539	309-389-4150 309-389-2849 Fax 309-360-7986 Cell
<b>Ordaz Construction Co. Inc.</b> Elizabeth Ordaz Mercer	WBE Concrete 8010 N. Sommer St., Peoria, IL 61615 <a href="mailto:lindahall@ordazconstruction.com">lindahall@ordazconstruction.com</a>	309-693-3338 309-693-5505 Fax
<b>P.A. Atherton Construction Inc.</b> Patricia Atherton	WBE Aggregate Pipe, Asphalt, Concrete, Demolition Excavation, Grading, Pavement Patching & Marking	309-822-8575 309-822-8782 Fax 309-645-9870 Cell
<b>Porter, V. L.</b> Vincent Porter	MBE Concrete, General 500 W. North, Suite 10, Springfield, IL 62704	217-744-8050
<b>Prairie Engineers of Illinois PC</b> Colleen Ayars	WBE Civil Engineering, Surveying ,Environmental Consulting 926 SW Adams Street, Suite 120, Peoria, IL 61602 <a href="http://www.prairieengineers.com">www.prairieengineers.com</a>	309-839-2642 217-718-4764 Fax
<b>Reign Construction</b> Bridget Booker	WBE/MBE Iron Worker 801 W. Main St., Suite A118, Peoria, IL 61606 <a href="mailto:bridget@reignconstructioninc.com">bridget@reignconstructioninc.com</a>	309-495-7982 309-495-7996 Fax 309-750-4846 Cell
<b>RNS Electric Inc.</b> Regina Slonneger	WBE Electrical 28558 Irish Lane, Washington, IL 61571	309-444-5200 309-444-5201 Fax
<b>Rudd Trucking</b> Nanette Jenkins-Rudd	WBE Trucking/Hauling P.O. Box 14, 107 Washington St., Kingston Mines, IL 61539	309-389-4150 309-389-2849 Fax
<b>Rufus Construction Company</b> Rufus Nelson	MBE Painting, Roofing, Remodeling 1819 S. Idaho Street, Peoria, IL 61605	309-673-6776 309-497-9453 Cell
<b>Searle Trucking, Inc.</b> Debbie Searle	WBE Trucking/Hauling P. O. Box 1084, Peoria, IL 61653	309-686-0708 309-688-5365 Fax
<b>Serenity Electric</b>	MBE Electrical PO Box 6521, Peoria, IL 61601 <a href="mailto:jamestaylor1955@yahoo.com">jamestaylor1955@yahoo.com</a>	309-363-5067 309-363-5067 Cell
<b>Sherwin Baker &amp; Associates Inc.</b> Sherwin Baker	MBE Engineering Technical Service, Construction Management 103 E. Archer, Peoria, IL 61603	309-688-4203 309-682-4203 Fax 309-678-2897 Cell <a href="mailto:sherwin_baker@yahoo.com">sherwin_baker@yahoo.com</a>
<b>Tabitha Ventures, Inc.</b> Edward O. Taiwo	MBE Asphalt, Concrete, Demolition, Earthwork, Electrical, Excavation, General, HVAC, Landscaping, Painting, Plumbing, Resurfacing, Roofing, Trucking/Hauling 100 N. Main Street, Suite 203, East Peoria, IL 61611	309-692-1473 309-692-1564 Fax <a href="mailto:information@tabithainc.com">information@tabithainc.com</a>
<b>TEMCO Heating &amp; AC</b> Ellen Robinson	WBE Heating & AC 913 Laramie St. Peoria, IL 61605	309-637-7746
<b>The Communication Connection</b> Jennifer Stone	WBE Communication, Wire and Cable, Electrical and Telephone Prod. 604 Filmore Street Harrisburg, PA 17104	717-561-7267
<b>Third Hand Landscaping</b> Tommy Harris	MBE Landscaping 2313 W. Lincoln, Peoria, IL 61605	309-673-6702
<b>Three Cross Development</b> J. T. Donelson	MBE Concrete, General, Sidewalk 1519 W. Millman Peoria, IL 61605	309-637-1238
<b>Thompson Brothers Inc.</b> Todd Thompson	MBE General Carpentry and Construction, Interior Finish Work, Millwork 221 Court St., Pekin, IL 61554	309-613-0254
<b>Thornton Rave</b> Demolition, Excavating and dba Illini Concrete Co. of Illinois	309-585-2376 Grading, Drainage, Aggregate Bases and Surfaces, Pavement Patching 929 E. Grove St., Suite A, Bloomington, IL 61701	MBE Precast and Prestressed Concrete, 309-585-2472 Fax 309-706-9213 Cell <a href="mailto:thorntonrave01@gmail.com">thorntonrave01@gmail.com</a>

**Tillman Electric**  
James Tillman

MBE Electrical  
4003 N. Rochelle, Peoria, IL 61615

309-685-8554  
309-264-3903 Cell

**Willie Veneble Construction**  
Willie Venable

MBE Construction, Concrete Removal, Demolition  
1000 E. Wilcox, Peoria, IL 61605

309-686-1429  
309-360-0757 Cell

**Willis Electric**  
Phyllis Willis

WBE Electrical  
P.O. Box 545, Chillicothe, IL 61523

309-579-2926

## Peoria County Prevailing Wage Rates posted on 3/3/2020

Trade Title	Rg	Type	C	Base	Foreman	Overtime				H/W	Pension	Vac	Trng	Other Ins
						M-F	Sa	Su	Hol					
ASBESTOS ABT-GEN	All	BLD		27.00	28.50	1.5	1.5	2.0	2.0	8.40	20.57	0.00	0.80	
ASBESTOS ABT-GEN	All	HWY		30.77	32.27	1.5	1.5	2.0	2.0	8.40	22.72	0.00	0.80	
ASBESTOS ABT-MEC	All	BLD		32.78	35.28	1.5	1.5	2.0	2.0	13.42	12.20	0.00	0.72	
BOILERMAKER	All	BLD		41.00	44.00	2.0	2.0	2.0	2.0	7.07	20.57	1.50	1.24	
BRICK MASON	All	BLD		35.01	36.51	1.5	1.5	2.0	2.0	10.60	11.70	0.00	0.84	
CARPENTER	All	BLD		33.05	35.30	1.5	1.5	2.0	2.0	8.65	18.75	0.00	0.55	
CARPENTER	All	HWY		35.43	37.68	1.5	1.5	2.0	2.0	8.65	19.60	0.00	0.52	
CEMENT MASON	All	BLD		31.48	33.23	1.5	1.5	2.0	2.0	8.75	17.60	0.00	0.64	
CEMENT MASON	All	HWY		32.98	34.48	1.5	1.5	2.0	2.0	8.75	18.21	0.00	0.67	
CERAMIC TILE FINISHER	All	BLD		32.63	32.63	1.5	1.5	2.0	2.0	10.60	11.70	0.00	0.82	
ELECTRIC PWR EQMT OP	All	ALL		46.47	55.07	1.5	1.5	2.0	2.0	7.39	13.01	0.00	0.69	
ELECTRIC PWR GRNDMAN	All	ALL		31.69	55.07	1.5	1.5	2.0	2.0	6.95	8.87	0.00	0.48	
ELECTRIC PWR LINEMAN	All	ALL		51.67	55.07	1.5	1.5	2.0	2.0	7.55	14.47	0.00	0.78	
ELECTRIC PWR TRK DRV	All	ALL		33.25	55.07	1.5	1.5	2.0	2.0	7.00	9.31	0.00	0.50	
ELECTRICIAN	All	BLD		38.25	40.75	1.5	1.5	2.0	2.0	8.15	13.45	0.00	0.80	
ELECTRONIC SYSTEM TECH	All	BLD		29.90	31.90	1.5	1.5	2.0	2.0	7.45	12.55	0.00	0.40	
ELEVATOR CONSTRUCTOR	All	BLD		47.72	53.68	2.0	2.0	2.0	2.0	15.72	18.41	3.82	0.63	
GLAZIER	All	BLD		35.87	37.87	1.5	1.5	1.5	2.0	12.25	8.90	0.00	1.25	
HEAT/FROST INSULATOR	All	BLD		43.70	46.20	1.5	1.5	2.0	2.0	13.42	13.66	0.00	0.72	
IRON WORKER	All	BLD		32.81	34.71	1.5	1.5	2.0	2.0	11.26	17.07	0.00	0.74	
IRON WORKER	All	HWY		38.20	40.20	1.5	1.5	2.0	2.0	11.26	17.07	0.00	0.74	
LABORER	All	BLD		26.00	27.50	1.5	1.5	2.0	2.0	8.40	20.57	0.00	0.80	
LABORER	All	HWY		30.02	31.52	1.5	1.5	2.0	2.0	8.40	22.72	0.00	0.80	
LABORER, SKILLED	All	BLD		26.40	27.90	1.5	1.5	2.0	2.0	8.40	20.57	0.00	0.80	
LABORER, SKILLED	All	HWY		30.32	31.82	1.5	1.5	2.0	2.0	8.40	22.72	0.00	0.80	
LATHER	All	BLD		33.05	35.30	1.5	1.5	2.0	2.0	8.65	18.75	0.00	0.55	
MACHINERY MOVER	All	HWY		36.82	38.82	1.5	1.5	2.0	2.0	10.66	15.47	0.00	0.64	
MACHINIST	All	BLD		48.93	51.43	1.5	1.5	2.0	2.0	7.68	8.95	1.85	1.32	
MARBLE FINISHER	All	BLD		32.63	32.63	1.5	1.5	2.0	2.0	10.60	11.70	0.00	0.82	
MARBLE MASON	All	BLD		35.37	36.62	1.5	1.5	2.0	2.0	10.60	11.70	0.00	0.84	
MILLWRIGHT	All	BLD		32.53	34.78	1.5	1.5	2.0	2.0	8.65	19.62	0.00	0.55	

MILLWRIGHT	All	HWY		35.55	37.80	1.5	1.5	2.0	2.0	8.65	20.05	0.00	0.52
OPERATING ENGINEER	All	BLD	1	40.74	43.74	1.5	1.5	2.0	2.0	10.25	20.65	0.00	3.60
OPERATING ENGINEER	All	BLD	2	37.71	43.74	1.5	1.5	2.0	2.0	10.25	20.65	0.00	3.60
OPERATING ENGINEER	All	BLD	3	32.70	43.74	1.5	1.5	2.0	2.0	10.25	20.65	0.00	3.60
OPERATING ENGINEER	All	HWY	1	40.75	43.75	1.5	1.5	2.0	2.0	10.25	20.65	0.00	3.60
OPERATING ENGINEER	All	HWY	2	37.72	43.75	1.5	1.5	2.0	2.0	10.25	20.65	0.00	3.60
OPERATING ENGINEER	All	HWY	3	32.71	43.75	1.5	1.5	2.0	2.0	10.25	20.65	0.00	3.60
PAINTER	All	ALL		37.35	39.35	1.5	1.5	1.5	2.0	12.10	9.30	0.00	1.35
PAINTER - SIGNS	All	BLD		39.84	44.74	1.5	1.5	2.0	2.0	2.73	3.39	0.00	0.00
PILEDRIIVER	All	BLD		34.05	36.30	1.5	1.5	2.0	2.0	8.65	18.75	0.00	0.55
PILEDRIIVER	All	HWY		35.43	37.68	1.5	1.5	2.0	2.0	8.65	19.60	0.00	0.52
PIPEFITTER	All	BLD		39.60	43.96	1.5	1.5	2.0	2.0	7.40	13.53	0.00	1.16
PLASTERER	All	BLD		30.06	31.31	1.5	1.5	2.0	2.0	8.75	18.16	0.00	0.90
PLUMBER	All	BLD		36.22	39.48	1.5	1.5	2.0	2.0	7.40	15.71	0.00	1.10
ROOFER	All	BLD		31.50	34.65	1.5	1.5	2.0	2.0	9.50	10.20	0.00	0.30
SHEETMETAL WORKER	All	BLD		34.19	35.90	1.5	1.5	2.0	2.0	10.12	17.74	0.00	0.98
SIGN HANGER	All	HWY		36.82	38.82	1.5	1.5	2.0	2.0	10.66	15.47	0.00	0.64
SPRINKLER FITTER	All	BLD		41.97	44.72	1.5	1.5	2.0	2.0	10.23	12.59	0.00	0.52
STEEL ERECTOR	All	HWY		36.82	38.82	1.5	1.5	2.0	2.0	10.66	15.47	0.00	0.64
STONE MASON	All	BLD		35.01	36.51	1.5	1.5	2.0	2.0	10.60	11.70	0.00	0.84
TERRAZZO FINISHER	All	BLD		32.63	32.63	1.5	1.5	2.0	2.0	10.60	11.70	0.00	0.82
TERRAZZO MASON	All	BLD		35.37	36.62	1.5	1.5	2.0	2.0	10.60	11.70	0.00	0.84
TILE MASON	All	BLD		35.37	36.62	1.5	1.5	2.0	2.0	10.60	11.70	0.00	0.84
TRUCK DRIVER	All	ALL	1	38.06	42.18	1.5	1.5	2.0	2.0	13.00	6.37	0.00	0.25
TRUCK DRIVER	All	ALL	2	38.61	42.18	1.5	1.5	2.0	2.0	13.00	6.37	0.00	0.25
TRUCK DRIVER	All	ALL	3	38.87	42.18	1.5	1.5	2.0	2.0	13.00	6.37	0.00	0.25
TRUCK DRIVER	All	ALL	4	39.23	42.18	1.5	1.5	2.0	2.0	13.00	6.37	0.00	0.25
TRUCK DRIVER	All	ALL	5	40.27	42.18	1.5	1.5	2.0	2.0	13.00	6.37	0.00	0.25
TRUCK DRIVER	All	O&C	1	30.45	33.74	1.5	1.5	2.0	2.0	13.00	6.37	0.00	0.25
TRUCK DRIVER	All	O&C	2	30.89	33.74	1.5	1.5	2.0	2.0	13.00	6.37	0.00	0.25
TRUCK DRIVER	All	O&C	3	31.10	33.74	1.5	1.5	2.0	2.0	13.00	6.37	0.00	0.25
TRUCK DRIVER	All	O&C	4	31.38	33.74	1.5	1.5	2.0	2.0	13.00	6.37	0.00	0.25
TRUCK DRIVER	All	O&C	5	32.22	33.74	1.5	1.5	2.0	2.0	13.00	6.37	0.00	0.25
TUCKPOINTER	All	BLD		35.01	36.51	1.5	1.5	2.0	2.0	10.60	11.70	0.00	0.84

## **Legend**

**Rg** Region

**Type** Trade Type - All,Highway,Building,Floating,Oil & Chip,Rivers

**C** Class

**Base** Base Wage Rate

**OT M-F** Unless otherwise noted, OT pay is required for any hour greater than 8 worked each day, Mon through Fri. The number listed is the multiple of the base wage.

**OT Sa** Overtime pay required for every hour worked on Saturdays

**OT Su** Overtime pay required for every hour worked on Sundays

**OT Hol** Overtime pay required for every hour worked on Holidays

**H/W** Health/Welfare benefit

**Vac** Vacation

**Trng** Training

**Other Ins** Employer hourly cost for any other type(s) of insurance provided for benefit of worker.

## Explanations PEORIA COUNTY

The following list is considered as those days for which holiday rates of wages for work performed apply: New Years Day, Memorial Day, Fourth of July, Labor Day, Thanksgiving Day, Christmas Day and Veterans Day in some classifications/counties. Generally, any of these holidays which fall on a Sunday is celebrated on the following Monday. This then makes work performed on that Monday payable at the appropriate overtime rate for holiday pay. Common practice in a given local may alter certain days of celebration. If in doubt, please check with IDOL.

Oil and chip resealing (O&C) means the application of road oils and liquid asphalt to coat an existing road surface, followed by application of aggregate chips or gravel to coated surface, and subsequent rolling of material to seal the surface.

## EXPLANATION OF CLASSES

**ASBESTOS - GENERAL** - removal of asbestos material/mold and hazardous materials from any place in a building, including mechanical systems where those mechanical systems are to be removed. This includes the removal of asbestos materials/mold and hazardous materials from ductwork or pipes in a building when the building is to be demolished at the time or at some close future date.

**ASBESTOS - MECHANICAL** - removal of asbestos material from mechanical systems, such as pipes, ducts, and boilers, where the mechanical systems are to remain.

## CERAMIC TILE FINISHER, MARBLE FINISHER, TERRAZZO FINISHER

Assisting, helping or supporting the tile, marble and terrazzo mechanic by performing their historic and traditional work assignments required to complete the proper installation of the work covered by said crafts. The term "Ceramic" is used for naming the classification only and is in no way a limitation of the product handled. Ceramic takes into consideration most hard tiles.

## ELECTRONIC SYSTEMS TECHNICIAN

Installation, service and maintenance of low-voltage systems which utilizes the transmission and/or transference of voice, sound, vision, or digital for commercial, education, security and entertainment purposes for the following: TV monitoring and surveillance, background/foreground music, intercom and telephone interconnect, field programming, inventory control systems, microwave transmission, multi-media, multiplex, radio page, school, intercom and sound burglar alarms and low voltage master clock systems.



Excluded from this classification are energy management systems, life safety systems, supervisory controls and data acquisition systems not intrinsic with the above listed systems, fire alarm systems, nurse call systems and raceways exceeding fifteen feet in length.

#### LABORER, SKILLED - BUILDING

The skilled laborer building (BLD) classification shall encompass the following types of work, irrespective of the site of the work: cutting & acetylene torch, gunnite nozzlemen, gunnite pump men & pots, kettlemen & carriers of men handling hot stuff, sandblaster nozzle men, sandblasting pump men & pots, setting up and using concrete burning bars, wood block setters, underpinning & shoring of existing buildings, and the unload-ing and handling of all material coated with creosote.

#### LABORER, SKILLED - HIGHWAY

The skilled laborer heavy & highway (HWY) classification shall encompass the following types of work,irrespective of the site of the work: jackhammer & drill operator, gunite pump & pot man, puddlers, vibrator men, wire fabric placer, sandblast pump & pot man, strike off concrete, unloading, handling & carrying of all creosoted piles, ties or timber, concrete burning bars, power wheelbarrows or buggies, asphalt raker, brickset-ters, cutting torchman (electric & acetylene), men setting lines to level forms, form setters, gunite nozzle man & sandblasting nozzle man, power man, and rip-rapping by hand.

TRUCK DRIVER - BUILDING, HEAVY AND HIGHWAY CONSTRUCTION Class 1. Drivers on 2 axle trucks hauling less than 9 ton. Air compressor and welding machines and brooms, including those pulled by separate units, truck driver helpers, warehouse employees, mechanic helpers, greasers and tiremen, pickup trucks when hauling materials, tools, or workers to and from and on-the-job site, and fork lifts up to 6,000 lb. capacity.

Class 2. Two or three axle trucks hauling more than 9 ton but hauling less than 16 ton. A-frame winch trucks, hydrolift trucks, vactor trucks or similar equipment when used for transportation purposes. Fork lifts over 6,000 lb. capacity, winch trucks, four axle combination units, and ticket writers.

Class 3. Two, three or four axle trucks hauling 16 ton or more. Drivers on water pulls, articulated dump trucks, mechanics and working forepersons, and dispatchers. Five axle or more combination units.

Class 4. Low Boy and Oil Distributors.

Class 5. Drivers who require special protective clothing while employed on hazardous waste work.

#### TRUCK DRIVER - OIL AND CHIP RESEALING ONLY.

This shall encompass laborers, workers and mechanics who drive contractor or subcontractor owned, leased, or hired pickup, dump, service, or oil distributor trucks. The work includes transporting materials and equipment (including but not limited to, oils, aggregate supplies, parts, machinery and tools) to or from the job site; distributing oil or liquid asphalt and aggregate; stock piling material when in connection with the actual oil and chip contract. The Truck Driver (Oil & Chip Resealing) wage classification does not include supplier delivered materials.

#### OPERATING ENGINEERS - BUILDING

Class 1. Cranes; Overhead Cranes; Gradall; All Cherry Pickers; Mechanics; Central Concrete Mixing Plant Operator; Road Pavers (27E - Dual Drum - Tri Batchers); Blacktop Plant Operators and Plant Engineers; 3 Drum Hoist; Derricks; Hydro Cranes; Shovels; Skimmer Scoops; Koehring Scooper; Drag Lines; Backhoe; Derrick Boats; Pile Drivers and Skid Rigs; Clamshells; Locomotive Cranes; Dredge (all types) Motor Patrol; Power Blades - Dumore - Elevating and similar types; Tower Cranes (Crawler-Mobile) and Stationary; Crane-type Backfiller; Drott Yumbo and similar types considered as Cranes; Caisson Rigs; Dozer; Tournadozer; Work Boats; Ross Carrier; Helicopter; Tournapulls - all and similar types; Scoops (all sizes); Pushcats; Endloaders (all types); Asphalt

Surfacing Machine; Slip Form Paver; Rock Crusher; Heavy Equipment Greaser; CMI, CMI Belt Placer, Auto Grade & 3 Track and similar types; Side Booms; Multiple Unit Earth Movers; Creter Crane; Trench Machine; Pump-crete-Belt Crete-Squeeze Cretes-Screw-type Pumps and Gypsum; Bulker & Pump - Operator will clean; Formless Finishing Machine; Flaherty Spreader or similar types; Screed Man on Laydown Machine; Wheel Tractors (industrial or Farm-type w/Dozer-Hoe-Endloader or other attachments); F.W.D. & Similar Types; Vermeer Concrete Saw.

Class 2. Dinkeys; Power Launches; PH One-pass Soil Cement Machine (and similar types); Pugmill with Pump; Backfillers; Euclid Loader; Forklifts; Jeeps w/Ditching Machine or other attachments; Tunneluger; Automatic Cement and Gravel Batching Plants; Mobile Drills (Soil Testing) and similar types; Gurries and Similar Types; (1) and (2) Drum Hoists (Buck Hoist and Similar Types); Chicago Boom; Boring Machine & Pipe Jacking Machine; Hydro Boom; Dewatering System; Straw Blower; Hydro Seeder; Assistant Heavy Equipment Greaser on Spread; Tractors (Track type) without Power Unit pulling Rollers; Rollers on Asphalt -- Brick Macadem; Concrete Breakers; Concrete Spreaders; Mule Pulling Rollers; Center Stripper; Cement Finishing Machines & CMI Texture & Reel Curing Machines; Cement Finishing Machine; Barber Green or similar loaders; Vibro Tamper (All similar types) Self-propelled; Winch or Boom Truck; Mechanical Bull Floats; Mixers over 3 Bag to 27E; Tractor pulling Power Blade or Elevating Grader; Porter Rex Rail; Clary Screed; Truck Type Hoptoe Oilers; Fireman; Spray Machine on Paving; Curb Machines; Truck Crane Oilers; Oil Distributor; Truck-Mounted Saws.

Class 3. Air Compressor; Power Subgrader; Straight Tractor; Trac Air without attachments; Herman Nelson Heater, Dravo, Warner, Silent Glo, and similar types; Roller: Five (5) Ton and under on Earth or Gravel; Form Grader; Crawler Crane & Skid Rig Oilers; Freight Elevators - permanently installed; Pump; Light Plant; Generator; Conveyor (1) or (2) - Operator will clean; Welding Machine; Mixer (3) Bag and Under (Standard Capacity with skip); Bulk Cement Plant; Oiler on Central Concrete Mixing Plant.

#### OPERATING ENGINEERS - HEAVY AND HIGHWAY CONSTRUCTION

CLASS 1. Cranes; Hydro Cranes; Shovels; Crane Type Backfiller; Tower, Mobile, Crawler, & Stationary Cranes; Derricks; Hoists (3 Drum); Draglines; Drott Yumbo & Similar Types considered as Cranes; 360 Degree Swing Excavator (Shears, Grapples, Movacs, etc.); Back Hoe; Derrick Boats; Pile Driver and Skid Rigs; Clam Shell; Locomotive - Cranes; Road Pavers - Single Drum - Dual Drum - Tri Batcher; Motor Patrols & Power Blades - Dumore - Elevating & Similar Types; Mechanics; Central Concrete Mixing Plant Operator; Asphalt Batch Plant Operators and Plant Engineers; Gradall; Caisson Rigs; Skimmer Scoop - Koering Scooper; Dredges (all types); Hoptoe; All Cherry Pickers; Work Boat; Ross Carrier; Helicopter; Dozer; Tournadozer; Tournapulls - all and similar types; Operation of Concrete and all Recycle Machines; Multiple Unit Earth Movers; Scoops (all sizes); Pushcats; Endloaders (all types); Asphalt Surfacing Machine; Slip Form Paver; Rock Crusher; Operation of Material Crusher, Screening Plants, and Tunnel Boring Machine; Heavy Equipment Greaser (top greaser on spread); CMI, Auto Grade, CMI Belt Placer & 3 Track and Similar Types; Side Booms; Asphalt Heater & Planer Combination (used to plane streets); Wheel Tractors (with Dozer, Hoe or Endloader Attachments); CAT Earthwork Compactors and Similar Types; Blaw Knox Spreader and Similar Types; Trench Machines; Pump Crete - Belt Crete - Squeeze Crete - Screw Type Pumps and Gypsum (operator will clean); Creter Crane; Operation of Concrete Pump Truck; Formless Finishing Machines; Flaherty Spreader or Similar Types; Screed Man on Laydown Machine; Vermeer Concrete Saw; Operation of Laser Screed; Span Saw; Dredge Leverman; Dredge Engineer; Lull or Similar Type; Hydro-Boom Truck; Operation of Guard Rail Machine; and Starting Engineer on Pipeline or Construction (11 or more pieces) including: Air Compressor (Trailer Mounted), All Forced Air Heaters (regardless of Size), Water Pumps (Greater than 4-1/2" or Total Discharge Over 4-1/2"), Light Plants, Generators (Trailer Mounted - Excluding Decontamination Trailer), Welding Machines (Any Size or Mode of Power), Conveyor, Mixer (any size), Stud Welder, Power Pac, etc, and Ground Heater (Trailer Mounted).

CLASS 2. Bulker & Pump; Power Launches; Boring Machine & Pipe Jacking Machine; Dinkeys; Operation of Carts, Powered Haul Unit for a Boring Machine; P & H One Pass Soil Cement Machines and Similar Types; Wheel Tractors (Industry or Farm Type - Other); Back Fillers; Euclid Loader; Fork Lifts; Jeep w/Ditching Machine or Other Attachments; Tunneluger; Automatic Cement & Gravel Batching Plants; Mobile Drills - Soil Testing and Similar Types; Pugmill with Pump; All (1) and (2) Drum Hoists; Dewatering System; Straw Blower; Hydro-Seeder; Bump Grinders (self-propelled); Assistant Heavy Equipment Greaser; Apsco Spreader; Tractors (Track-Type) without Power Units Pulling Rollers; Rollers on Asphalt - Brick or Macadam; Concrete Breakers; Concrete

Spreaders; Cement Strippers; Cement Finishing Machines & CMI Texture & Reel Curing Machines; Vibro-Tampers (All Similar Types Self-Propelled); Mechanical Bull Floats; Self-Propelled Concrete Saws; Truck Mounted Power Saws; Operation of Curb Cutters; Mixers - Over Three (3) Bags; Winch and Boom Trucks; Tractor Pulling Power Blade or Elevating Grader; Porter Rex Rail; Clary Screed; Mule Pulling Rollers; Pugmill without Pump; Barber Greene or Similar Loaders; Track Type Tractor w/Power Unit attached (minimum); Fireman; Spray Machine on Paving; Curb Machines; Paved Ditch Machine; Power Broom; Self-Propelled Sweepers; Self-Propelled Conveyors; Power Subgrader; Oil Distributor; Straight Tractor; Truck Crane Oiler; Truck Type Oilers; Directional Boring Machine; Horizontal Directional Drill; Articulating End Dump Vehicles; Starting Engineer on Pipeline or Construction (6 -10 pieces) including: Air Compressor (Trailer Mounted), All Forced Air Heaters (regardless of Size), Water Pumps (Greater than 4-1/2" or Total Discharge Over 4-1/2"), Light Plants, Generators (Trailer Mounted - Excluding Decontamination Trailer), Welding Machines (Any Size or Mode of Power), Conveyor, Mixer (any size), Stud Welder, Power Pac, etc., and Ground Heater (Trailer Mounted).

CLASS 3. Straight Framed Truck Mounted Vac Unit (separately powered); Trac Air Machine (without attachments); Rollers - Five Ton and Under on Earth and Gravel; Form Graders; Bulk Cement Plant; Oilers; and Starting Engineer on Pipeline or Construction (3 - 5 pieces) including: Air Compressor (Trailer Mounted), All Forced Air Heaters (regardless of Size), Water Pumps (Greater than 4-1/2" or Total Discharge Over 4-1/2"), Light Plants, Generators (Trailer Mounted - Excluding Decontamination Trailer), Welding Machines (Any Size or Mode of Power), Conveyor, Mixer (any size), Stud Welder, Power Pac, etc., and Ground Heater (Trailer Mounted).

#### Other Classifications of Work:

For definitions of classifications not otherwise set out, the Department generally has on file such definitions which are available. If a task to be performed is not subject to one of the classifications of pay set out, the Department will upon being contacted state which neighboring county has such a classification and provide such rate, such rate being deemed to exist by reference in this document. If no neighboring county rate applies to the task, the Department shall undertake a special determination, such special determination being then deemed to have existed under this determination. If a project requires these, or any classification not listed, please contact IDOL at 217-782-1710 for wage rates or clarifications.

#### LANDSCAPING

Landscaping work falls under the existing classifications for laborer, operating engineer and truck driver. The work performed by landscape plantsman and landscape laborer is covered by the existing classification of laborer. The work performed by landscape operators (regardless of equipment used or its size) is covered by the classifications of operating engineer. The work performed by landscape truck drivers (regardless of size of truck driven) is covered by the classifications of truck driver.

## SAMPLE ADDENDUM

Peoria Park District  
Planning, Design and Construction Department  
1314 N. Park Road  
Peoria, IL 61604  
Telephone: (309) 686-3386

ADDENDUM NO. \_\_\_\_\_

PROJECT TITLE: \_\_\_\_\_

ISSUANCE DATE: \_\_\_\_\_

LOCATION: \_\_\_\_\_

The proposed Contract Documents for this Work are modified as follows:

- I. **GENERAL INFORMATION:**
  
- II. **DRAWINGS:** (Delete/Change/Modify/Etc.)
  
- III. **PROJECT MANUAL/SPECIFICATIONS.:**  
(Delete/Change/Modify/Etc.)
  
- IV. **INVITATION TO BID:** (Delete/Change/Modify/Etc.)

END OF ADDENDUM NO. \_\_\_\_\_

(Addendum may be bound into Project Manual, attached to front cover, faxed, mailed, emailed or delivered to bidders.)

Addendum No. \_\_\_\_\_  
Page 1 of 1



**Pleasure Driveway and Park District of Peoria, Illinois**  
**Sample Agreement Between Owner and Contractor**

---

This **AGREEMENT** for

CURB & GUTTER IMPROVEMENTS NORTH/UPPER  
BRADLEY PARK  
PEORIA, IL 61604

is made as of the \_\_\_\_\_ day of \_\_\_\_\_ in the year of Two Thousand Twenty (2020)

**Between the Owner:**

PLEASURE DRIVEWAY AND PARK DISTRICT OF PEORIA, ILLINOIS  
1125 W. LAKE AVENUE  
PEORIA, IL 61614

**And the Contractor:**

**The Owner's Representative is:**

PLANNING, DESIGN AND CONSTRUCTION DEPARTMENT  
1314 N. PARK ROAD  
PEORIA, IL 61604

**The Architect or Engineer is:**

ZUMWALT & ASSOCIATES  
1040 W. OLYMPIA DRIVE  
PEORIA, IL 61615

The Owner and Contractor agree as follows:

**I. THE CONTRACT DOCUMENTS.** The Contract Documents consist of this AGREEMENT, the Plans/Drawings for the Project dated May 19, 2020 all sections of the Project Manual dated May 19, 2020, including but not limited to the Instructions and Supplementary Instructions to Bidders, the Bid Form, the General Conditions (1997 AIA Document A201) and Supplementary General Conditions, the General Requirements, the Specifications, and other documents as enumerated in Section 10 and Attachment #1 of this AGREEMENT, and including addenda issued prior to the execution of this AGREEMENT. The Contract Documents form the CONTRACT between the Owner and the Contractor. The CONTRACT represents the entire and integrated contract for the construction of the Work of the Project between the parties hereto and supersedes prior proposals, contracts, negotiations, or representations, either written or oral.

**II. THE WORK OF THE CONTRACT.** The Contractor shall execute the entire Work described in the Contract Documents, unless modified in Section XI of this AGREEMENT.

**III. BASIS OF PAYMENT.** The Work of the CONTRACT shall be performed on a lump sum basis.

**IV. CONTRACT SUM.** The Owner shall pay the Contractor the sum of

(and incorporates the acceptance of bid alternates as defined in sub-paragraph "A", below) for the Contractor's performance of the Work required by the Contract Documents, subject to modifications made by Owner approved Change Orders. If this CONTRACT calls for a unit price basis of payment, the contract sum stated above shall be adjusted by Change Order based upon multiplying the unit prices submitted by the Contractor on the Bid Form (and included herein as an Attachment to this CONTRACT) times (x) the actual quantities installed.

**A. ACCEPTANCE OF ALTERNATES.** The contract sum stated above is based on the acceptance of the following alternates, which are described in the Project Manual:

<u>ITEM</u>	<u>ADD</u>	<u>DEDUCT</u>

**V. DATES OF COMMENCEMENT AND COMPLETION OF THE WORK.** The Owner's Representative will issue a written Notice to Proceed with the Work of the Project after receiving the required Performance Bond, Labor and Material Payment Bond, and Certificate of Insurance (in proper form and providing the required coverages and amounts from a company [or companies] acceptable to the Owner, and naming the Owner as an Additional Insured), and any other pre-construction submittals required by the Contract Documents. The Contractor hereby acknowledges and agrees that failure to provide such submittals in a timely manner shall not be cause to adjust the date(s) for completion of the Work.

- A. LIQUIDATED DAMAGES.** Owner and Contractor recognize that time is of the essence of this CONTRACT and that Owner will suffer financial loss if the Contractor has not achieved Substantial Completion and Final Completion of the Work within the time specified below, plus any extensions thereof allowed in accordance with Article 8 of the General Conditions. They also recognize the delays, expense and difficulties involved in proving in a legal or arbitration proceeding the actual loss suffered by Owner if the Work is not completed on time.
- B. SUBSTANTIAL COMPLETION.** Accordingly, instead of requiring any such proof, Owner and Contractor agree that as Liquidated Damages for delay (but not as a penalty), Contractor shall pay Owner Two-Hundred Fifty dollars (\$250.00) for each calendar day that expires after Seventy-nine (79) calendar days from Notice of Award until Substantial Completion is attained. The work is tentatively scheduled to begin on June 11, 2020 and be at Substantial Completion by August 28, 2020.
- C. FINAL COMPLETION.** After Substantial Completion if Contractor shall neglect, refuse, or fail to complete the remaining Work necessary to achieve Final Completion within ten (10) calendar days or any proper extension thereof granted by Owner, Contractor shall pay Owner Two-Hundred Fifty dollars (\$250.00) for each day that expires after the time specified.

**VI. PROGRESS PAYMENTS, REDUCTION OF RETAINAGE AND FINAL PAYMENT.**

- A.** Unless otherwise specified elsewhere in the Contract Documents, the Contractor may submit monthly applications for progress payments ("Application for Payment") to the Owner's Representative. Each Application for Payment must be certified by the Architect or Engineer (if applicable), or the Owner's Representative if an Architect or Engineer has not been engaged for construction phase services. An Application for Payment shall be for a period of no less than one calendar month ending on the last day of the month, unless otherwise approved in writing by the Owner's Representative. Application forms shall be subject to Owner's approval. Each Application for Payment shall be based upon the Schedule of Values submitted by the Contractor, in accordance with the Contract Documents. The Schedule of Values shall be approved by the Owner's Representative and the Architect or Engineer (if applicable) in advance of the Contractor's first Application for Payment and the approved schedule shall be used by the Contractor as the basis for submitting payment requests. The Owner's Representative and/or

Architect/Engineer's (if applicable) approval of the Schedule of Values shall not constitute a complete check for accuracy, and shall not relieve the Contractor from responsibility for errors of any sort.

- B. An Application for Payment (certified by the Architect or Engineer, if applicable) shall be submitted to the Owner's Representative no later than the fifth (5th) day of the month following the period for which the application is being submitted. In such case, the Owner shall make the progress payment to the Contractor not later than the twentieth day of the next month. A progress payment request on an Application for Payment (certified by the Architect or Engineer, if applicable) received by the Owner's Representative after the fifth (5th) day of a month shall be made by the Owner not later than forty-five days after receipt by the Owner's Representative.
- C. Based upon its review of the certified (by the Architect or Engineer, if applicable) Application for Payment, the Owner shall make a progress payment to the Contractor in such amount as the Owner reasonably determines is properly due, subject to a retainage of ten percent (10%) of the value of the Work completed and covered by the Application for Payment, less the aggregate of previous payments in each case. In determining the amount properly due, the Owner shall consider the value of labor, materials and equipment incorporated in the Work, or properly allocable to materials and equipment suitably stored at the site or at some other location previously agreed upon in writing by the parties. The Owner's Representative shall have the sole right to determine that materials or equipment stored off-site have been properly delivered, protected, and/or secured. The Owner's Representative (or the Architect or Engineer, if applicable) may nullify or withhold a Certificate of Payment, in whole or in part, for the reasons set forth in Section 9.5 of the General Conditions. Upon Substantial Completion of the Work, the Owner shall pay the Contractor a sum sufficient to increase the total payments to ninety-five percent (95%) of the Contract Sum, less such amounts as the Owner's Representative shall determine for incomplete work and unsettled claims.

**VII.** Final payment, constituting the entire unpaid balance of the Contract Sum, shall be made by the Owner when **1)** the Contract has been fully performed by the Contractor except for the Contractor's responsibility to correct nonconforming Work as provided in Subparagraph 12.2.2 of the General Conditions and to satisfy other requirements, if any, which necessarily survive final payment; and **2)** a final Certificate of Payment has been issued by the Architect/Engineer or Owner's Representative; such final payment shall be made by the Owner not more than forty-five (45) days after the receipt of the final Certificate of Payment by the Owner.

**VIII. CHANGE ORDERS.** The Owner and Contractor agree that changes in the Work are sometimes required and necessary, and that timely: **a)** submission of proposed changes in the Work or the scope of Work by the Owner, **b)** pricing by the Contractor, **c)** review by the Owner's Representative and/or Architect/Engineer, and **d)** final approval by the Owner are necessary in order to assure that the Work of the Project is completed on schedule. The Contractor hereby acknowledges and agrees that an increase in the scope of the Work does not grant or imply an increase in the Contract Time, unless specifically so stated on the final approved Change Order. The Contractor also agrees that any and all Work which deviates from the plans and specifications and/or results in additional Work performed by Contractor's forces, including those of his sub-contractor's, will not result in additional expense to the Owner, unless finally approved both by the Owner and the Architect/Engineer (if applicable) prior to the additional Work being performed. No claim for an addition to the Contract Sum shall be valid unless approved by a written Change Order signed by the Owner and the architect/engineer (if applicable) prior to the additional Work being performed.

**IX. TERMINATION OR SUSPENSION.** The CONTRACT may be terminated by the Owner or the Contractor as provided by Article 14 of the General Conditions. The Work may be suspended by the Owner as provided in Article 14 of the General Conditions.

**X. ENUMERATION OF CONTRACT DOCUMENTS.** The Contract Documents, except for modifications issued after the execution of this Agreement, consist of:

- A. this Standard Form of Agreement Between Owner and Contractor, of the Pleasure Driveway and Park District of Peoria, Illinois.
- B. the Plans or Drawings titled “Curb and Gutter Improvements North/Upper, Bradley Park”, dated May 19, 2020, and enumerated in ATTACHMENT #1 - "LIST OF DRAWINGS".
- C. Supplementary and other Conditions of the CONTRACT, and the Specifications, are those found in the Project Manual titled " Curb and Gutter Improvements North/Upper, Bradley Park", and dated May 19, 2020 enumerated as follows:
  - 1) Supplementary Instructions to Bidders
  - 2) Contractor's Proposal, as accepted by the Owner
  - 3) General Conditions of the Contract for Construction, AIA Document A201, 1997 Edition
  - 4) Supplementary General Conditions
  - 5) Major Subcontractor List
  - 6) Directory of Minority & Women Owned Business Enterprises
  - 7) Certification of Compliance for Listed Provisions and Laws
  - 8) Peoria Park District Certificate of Equal Employment Opportunity Compliance for Contractors and Vendors
  - 9) Workforce Profile
  - 10) Minority/Women Owned Contact Sheet
  - 11) Performance Bond
  - 12) Labor and Material Payment Bond
  - 13) Proof of Insurance
  - 14) Specifications: Division 010000, "General Requirements"; Divisions 020000-350000 as applicable
  - 15) Attachment A.6- Insurance Requirements
  - 16) Peoria Park District Weekly Workforce Report
  - 17) Certified Payroll Form

**XI. MISCELLANEOUS PROVISIONS.** Other Provisions of this Agreement are as follows:



This AGREEMENT is entered into as of the day and year first written above and is executed in at least three original copies of which one is to be delivered to the Contractor, one to the Architect/Engineer (if any) for use in the administration of the CONTRACT, and one to the Owner.

**OWNER:**

**CONTRACTOR :**

\_\_\_\_\_  
(Signature)

\_\_\_\_\_  
(Signature)

ROBERT L. JOHNSON, SR., Park Board President

\_\_\_\_\_  
(Printed Name and Title)

ATTEST:

ATTEST:

## ATTACHMENT #1 - LIST OF DRAWINGS

C0.0	COVER SHEET
V1.1	EXISTING TOPOGRAPHY SURVEY- NORTH
V1.2	EXISTING TOPOGRAPHY SURVEY- SOUTH
C1.1	OVERALL SITE PLAN & GENERAL NOTES
CD1.1	SITE REMOVAL PLAN- NORTH
CD1.2	SITE REMOVAL PLAN- SOUTH
C2.1	SITE GRADING PLAN- NORTH
C2.2	SITE GRADING PLAN- SOUTH
C3.1	STORMWATER POLLUTION PREVENTION PLAN, DETAILS AND NOTES

**PERFORMANCE BOND**

**TO: PLEASURE DRIVEWAY AND PARK DISTRICT OF PEORIA  
PEORIA, ILLINOIS**

**KNOW ALL MEN BY THESE PRESENTS;**

That \_\_\_\_\_  
\_\_\_\_\_ as Principal, and \_\_\_\_\_ as  
corporation of the State of \_\_\_\_\_, as Surety, are held and firmly bound unto the  
PLEASURE DRIVEWAY AND PARK DISTRICT OF PEORIA, PEORIA, ILLINOIS, as Obligee, in the amount of \_\_\_\_\_  
(\$ \_\_\_\_\_), for the payment whereof Principal and Surety bind themselves, their heirs, executors, administrators,  
successors and assigns, jointly and severally, firmly by these presents.

WHEREAS, Principal has by written agreement dated \_\_\_\_\_, 20 \_\_\_\_\_ entered into a contract  
with Obligee for \_\_\_\_\_  
in accordance with contract documents prepared by the Architect-Engineer, which Contract is by reference made a part hereof and  
is hereinafter referred to as "the Contract".

NOW, THEREFORE, THE CONDITION OF THIS OBLIGATION is such that if Principal shall promptly and faithfully  
perform the Contract and all changes thereof, and during the life of any guaranty or warranty required under the Contract, and, if  
Principal shall fully secure and protect the Obligee from all liability and from all loss or expense of any kind, including all court  
costs, engineering fees and attorneys' fees made necessary or arising from the failure, refusal or neglect of Principal to comply  
with all obligations assumed by Principal in connection with the performance of the Contract and all changes thereof, then this  
obligation shall be null and void; otherwise it shall remain in full force and effect.

Surety hereby waives notice of any changes in the Contract, including extensions of time for the performance thereof. Whenever  
Principal shall be and is declared to be in default under the Contract, Obligee having performed Obligee's obligations thereunder,  
Surety shall, after notice of such default, reserve all rights against all parties, take over and complete the Contract and become  
entitled to payment of the balance of any monies due or to become due to such defined Principal in accordance with the progress  
of the work.

A condition of this Bond is that the Principal shall faithfully perform in accordance with the prevailing wage clause provided in  
the bid specification or Contract pursuant to Illinois Compiled Statutes 820 ILCS 130/1 *et. seq.*

No right of action shall accrue on this Bond to or for the use of any person or corporation other than the Obligee named  
herein.

Signed and Sealed this \_\_\_\_\_ day of \_\_\_\_\_, 20 \_\_\_\_\_.

**CONTRACTOR**

\_\_\_\_\_  
Contractor Firm Name

By: \_\_\_\_\_  
Signature

\_\_\_\_\_  
Title

**SURETY**

\_\_\_\_\_  
Surety Name

By: \_\_\_\_\_  
Attorney-in-Fact

\_\_\_\_\_  
Resident Agent

ATTEST:

\_\_\_\_\_  
Corporate Secretary (Corporations only)

**LABOR & MATERIAL PAYMENT BOND**

**TO: PLEASURE DRIVEWAY AND PARK DISTRICT OF PEORIA  
PEORIA, ILLINOIS**

**KNOW ALL MEN BY THESE PRESENTS:**

That: \_\_\_\_\_

as Principal, and \_\_\_\_\_

\_\_\_\_\_ a corporation of the State of \_\_\_\_\_ as Surety, are held and firmly bound unto the PLEASURE DRIVEWAY AND PARK DISTRICT OF PEORIA, PEORIA, ILLINOIS, as Obligees, for the use and benefit of claimants as hereinafter defined in the amount of \_\_\_\_\_ Dollars (\$ \_\_\_\_\_), for the payment whereof Principal and Surety bind themselves, their heirs, executors, administrators, successors and assigns, jointly and severally, firmly by these presents.

WHEREAS, Principal has by written agreement dated \_\_\_\_\_, 20 \_\_\_\_\_, entered into a Contract with Obligees for \_\_\_\_\_

\_\_\_\_\_ in accordance with contract documents prepared by the Architect-Engineer which Contract is by reference made a part hereof, and is hereinafter referred to as "the Contract".

**NOW, THEREFORE, THE CONDITION OF THIS OBLIGATION** is such that if Principal shall promptly pay for all laborers, workers and mechanics engaged in the work under the Contract, and not less than the general prevailing rate of hourly wages of a similar character in the locality in which the work is performed, as determined by the State of Illinois Department of Labor pursuant to the Illinois Compiled Statutes 820 ILCS 130/1 et. seq. and for all material used or reasonably required for use in the performance of the Contract, then this obligation shall be void; otherwise it shall remain in full force and effect.

1. A claimant is defined as any person, firm, or corporation having contracts with the Principal or with any of Principal's subcontractors for labor or materials furnished in the performance of the Contract on account of which this Bond is given.

2. Nothing in this Bond contained shall be taken to make the Obligees liable to any subcontractor, materialman or laborer, or to any other person to any greater extent than it would have been liable prior to the enactment of The Public Construction Bond Act, approved June 20, 1931, as amended; provided further, that any person having a claim for labor and materials furnished in the performance of the Contract shall have no right of action unless he shall have filed a verified notice of such claim with the Obligees within 180 days after the date of the last item of work or the furnishing of the last item of materials, which claim shall have been verified and shall contain the name and address of the claimant, the business address of the claimant within the State of Illinois, if any, or if the claimant be a foreign corporation having no place of business within the State the principal place of business of the corporation, and in all cases of partnership the names and residences of each of the partners, the name of the Contractor for the Obligees, the name of the person, firm or corporation by whom the claimant was employed or to whom such claimant furnished materials, the amount of the claim and a brief description of the public improvement for the construction or installation of which the Contract is to be performed. No defect in the notice herein provided for shall deprive the claimant of its right of action under the terms and provisions of this Bond unless it shall affirmatively appear that such defect has prejudiced the rights of an interested party asserting the same.

3. No action shall be brought on this Bond until the expiration of 120 days after the date of the last item of work or of the furnishing of the last item of material except in cases where the final settlement between the Obligees and the Contractor shall have been made prior to the expiration of the 120 day period, in which case action may be taken immediately following such final settlement; nor shall any action of any kind be brought later than 6 months after the acceptance by the Obligees of the work. Such suit shall be brought only in the circuit court of this State in the judicial district in which the Contract is to be performed.

4. Surety hereby waives notice of any changes in the Contract, including extensions of time for the performance thereof.
5. The amount of this Bond shall be reduced by and to the extent of any payment or payments made in good faith hereunder.
6. The Principal and Surety shall be liable for any attorneys fees, engineering costs, or court costs incurred by the Obligee relative to claims made against this Bond.

Signed and Sealed this \_\_\_\_\_ day of \_\_\_\_\_, 20\_\_\_\_\_.

**CONTRACTOR**

**SURETY**

Contractor Firm Name:

\_\_\_\_\_

\_\_\_\_\_

By: \_\_\_\_\_  
Signature

By: \_\_\_\_\_  
Attorney-in-Fact

\_\_\_\_\_  
Title

\_\_\_\_\_  
Resident Agent

ATTEST:

\_\_\_\_\_  
Corporate Secretary (Corporations only)

**CONTRACTOR'S AFFIDAVIT**

STATE OF ILLINOIS )  
                                  ) SS  
COUNTY OF PEORIA )

TO WHOM IT MAY CONCERN:

THE undersigned, being duly sworn, deposes and says that he is \_\_\_\_\_  
\_\_\_\_\_ of the \_\_\_\_\_  
who is the contractor for the \_\_\_\_\_  
building located at \_\_\_\_\_  
owned by \_\_\_\_\_.

That the total amount of the contract including extras is \$ \_\_\_\_\_ on which he has received payment  
of \$ \_\_\_\_\_ prior to this payment. That all waivers are true, correct and genuine and delivered  
unconditionally and that there is no claim either legal or equitable to defeat the validity of said waivers. That the following are the  
names of all parties who have furnished material or labor, or both, for said work and all parties having contracts or sub-contracts  
for specific portions of said work or for material entering into the construction thereof and the amount due or to become due to  
each, and that the items mentioned include all labor and material required to complete said work according to plans and  
specifications:

NAMES	WHAT FOR	CONTRACT PRICE	AMOUNT PAID	THIS PMT.	BALANCE DUE

TOTAL ALL LABOR AND MATERIAL TO COMPLETE

There are no other contracts for said work outstanding, and that there is nothing due or to become due to any person for material,  
labor or other work of any kind done or to be done upon or in connection with said work other than above stated.

Signed this \_\_\_\_\_ day of \_\_\_\_\_, 20 \_\_\_\_.

Signature: \_\_\_\_\_

Subscribed and sworn to before me this \_\_\_\_\_ day of \_\_\_\_\_, 20 \_\_\_\_.

\_\_\_\_\_  
Notary Public

**FINAL WAIVER OF LIEN**

STATE OF ILLINOIS    )  
                                  ) SS  
COUNTY OF PEORIA    )

TO WHOM IT MAY CONCERN:

WHEREAS, the undersigned \_\_\_\_\_ ha \_\_\_\_\_ been employed by THE PEORIA PARK DISTRICT to furnish material and labor for the \_\_\_\_\_ at the premises commonly known as \_\_\_\_\_ located in the City of \_\_\_\_\_, County of Peoria, State of Illinois.

The undersigned, for and in consideration of \_\_\_\_\_ (\$ \_\_\_\_\_) Dollars, and other good and valuable considerations, the receipt whereof is hereby acknowledged, do \_\_\_\_\_ hereby waive and release any and all lien or claim or right of lien under the statutes of the State of Illinois relating to mechanics' liens, with respect to and on said above-described premises and improvements thereon and on the money, funds or other considerations due or become due from the owner on account of labor or services, material, fixtures, apparatus or machinery heretofore furnished or which may be furnished at any time hereafter by the undersigned for the above described premises.

Dated this \_\_\_\_\_ day of \_\_\_\_\_ 20 \_\_\_\_\_.

[Affix corporate seal here.]

\_\_\_\_\_  
(Name of sole owner, corporation or partnership)

ATTEST:

\_\_\_\_\_  
(Signature of secretary of corporation)

\_\_\_\_\_  
(Signature of sole owner or authorized representative of corporation or partnership) (SEAL)



**WAIVER OF LIEN**

**GENERAL CONTRACTOR'S PARTIAL  
TO COVER ONLY CERTAIN PAYMENTS**

STATE OF ILLINOIS    )  
                                  ) SS  
COUNTY OF PEORIA    )

TO ALL WHOM IT MAY CONCERN:

WHEREAS, the undersigned \_\_\_\_\_ has been employed  
by THE PEORIA PARK DISTRICT to furnish material and labor for the \_\_\_\_\_ at  
the premises commonly known as \_\_\_\_\_

\_\_\_\_\_ located in the City of Peoria, County of Peoria, and State of Illinois.

NOW, THEREFORE, the undersigned, for and in consideration of the sum of \_\_\_\_\_ Dollars, and other good and valuable considerations, the receipt whereof is hereby acknowledged by the undersigned, does hereby waive and release to the extent only of the aforesaid amount of \_\_\_\_\_ Dollars, paid simultaneously herewith, any and all lien or right or claim of lien under the statutes of the State of Illinois relating to mechanics' liens, with respect to and on said above-described premises, and the improvements thereon and on the money, funds, or other consideration due or to become due from the owner on account of labor, services, material, fixtures, apparatus or machinery, furnished by the undersigned, to or on account of the said owner, for the above-described premises, but only to the extent of the payment aforesaid.

Dated this \_\_\_\_\_ day of \_\_\_\_\_, 20 \_\_\_\_\_.

[Affix corporate seal here]

\_\_\_\_\_  
(Name of sole owner, corporation or partnership)

ATTEST:

\_\_\_\_\_  
(Signature of secretary of corporation)

\_\_\_\_\_  
(SEAL)  
(Signature of sole owner or authorized representative of corporation or partnership)





# **PEORIA PARK DISTRICT**

## **Weekly Workforce Report**

### **Instructions**

This weekly workforce report must be completed and returned to the Peoria Park District project manager for each week that you are working on Peoria Park District property. You are to report only those employees that are actually working on the Peoria Park District project identified on this report. Do not report employees that are not working on the project identified on this report.

If you have further questions regarding this report, please contact the Owner's Project Manager.

#### I. Trade and Hour Breakdown Table

- List the different trades (carpenter, laborer, plumber, etc.) and report the number of hours by race/gender for each trade;
- Total the hours for each trade on the right.

#### II. New Hires by Race and Gender

- If additional employees are hired for the job, please record the number of employees hired by race/gender.

#### III. Total Project Employee Breakdown

- Please track total hours by race/gender for the project if project lasts longer than a week.

**Weekly Workforce Report (Peoria Park District Form) Date: \_\_\_\_\_ Week Ending: \_\_\_\_\_**

**Contractor/Subcontractor: \_\_\_\_\_ Project: \_\_\_\_\_**

**Trade & Hour Breakdown:**

TRADE	FEMALE HOURS	CAUCASIAN HOURS	AFRICAN-AMERICAN HOURS	HISPANIC HOURS	NATIVE AMERICAN HOURS	ASIAN, PAC. ISLANDER HOURS	TOTAL HOURS

**New Hires by Race & Gender**

TRADE	CAUCASIAN	AFRICAN-AMERICAN	HISPANIC	NATIVE AMERICAN	ASIAN, PACIFIC ISLANDER	MALE	FEMALE

**Total Project Employee Breakdown**

	CAUCASIAN	AFRICAN-AMERICAN	HISPANIC	NATIVE AMERICAN	ASIAN, PACIFIC ISLANDER	MALE	FEMALE

# Certified Transcript of Payroll

IDOL Case File Number: \_\_\_\_\_ Payroll Start: \_\_\_\_\_

Payroll End: \_\_\_\_\_

### Contractor and/or Subcontractor

### Public Body Information

_____ (Contract Number)	_____ (Company Name)	_____ (Contact Name)
_____ (Project Number)	_____ (Street Address)	_____ (City)
_____ (Project Location)	_____ (State)      _____ (Zipcode)	_____ (Telephone Number)

Report Hours for Each Day, Including Overtime Hours, List Hourly Prevailing Wage Rate and Hourly Fringe Benefits Allotments.

Worker Name, Address Last Four of SSN & Telephone Number	PW	* Hours worked each day							Total Straight Time Hours	Total OT Hours	Hourly Wage Rate	OT Wage Rate	Per Pay Period	
		SUN	MON	TUE	WED	THR	FRI	SAT					Gross	Net
	N													
Labor Classification _____		Hourly Fringe Benefit:    Pension: _____    Health/Welfare: _____    Vacation: _____    Training: _____												
	N													
Labor Classification _____		Hourly Fringe Benefit:    Pension: _____    Health/Welfare: _____    Vacation: _____    Training: _____												
	N													
Labor Classification _____		Hourly Fringe Benefit:    Pension: _____    Health/Welfare: _____    Vacation: _____    Training: _____												

Please place an "F" by the hourly rate for fringe benefits paid to a Fund jointly managed by one or more labor organizations or employers in accordance with the federal Labor Management Relations Act (See instruction 4 for completing this form). In addition contractors/subcontractors who do not make contributions for covered fringe benefits to a fringe benefit fund that is jointly managed and jointly governed by one or more labor organizations or employers in accordance with the federal Labor Management Relations Act must provide the additional information set forth on the form on page 2 (see Instruction 5). Contractors/subcontractors who do not make contributions for fringe benefits on a per hour basis for each hour worked must convert such contributions to an annualized per hour basis for purpose of reporting on this form in accordance with instruction 5. You must keep original records showing start and end time each day.

**\*PW - Prevailing Hours Worked \*N - Non Prevailing Hours Worked**



# Certified Transcript of Payroll

## AFFIDAVIT

Weekly Statement of Compliance

Date: \_\_\_\_\_

I, \_\_\_\_\_,  
(name signatory party)  
\_\_\_\_\_, do  
(Title)

hereby state: that I pay or supervise the payment  
of the persons employed on the public works  
project \_\_\_\_\_;

(name of project)  
that during the payroll period commencing on the  
\_\_\_\_\_ day of \_\_\_\_\_,  
(day) (month) (year)

all persons employed on said project have been  
paid the full weekly wages earned, that no  
rebates have been or will be made either directly  
or indirectly to or on behalf of said

\_\_\_\_\_  
(name of contractor or subcontractor)  
from the full weekly wages earned by any person,  
and that no deductions have been made either  
directly or indirectly from the full weekly wages  
earned by any persons, other than permissible  
deductions as defined by Federal and/or State  
Law. I further certify that this payroll is correct  
and complete; that the wage rates contained  
therein are not less than the actual rates herein  
stated and that the classification set forth for each  
laborers or mechanic conform to the work he/she  
performed.

\_\_\_\_\_  
Signature

Digital Signature \_\_\_\_\_

## FRINGES

Health Fund \_\_\_\_\_  
Health Address \_\_\_\_\_  
Health Sponsor \_\_\_\_\_  
Health Admin \_\_\_\_\_

Pension Fund \_\_\_\_\_  
Pension Address \_\_\_\_\_  
Pension Sponsor \_\_\_\_\_  
Pension Admin \_\_\_\_\_

401(k) Fund \_\_\_\_\_  
401(k) Address \_\_\_\_\_  
401(k) Sponsor \_\_\_\_\_  
401(k) Admin \_\_\_\_\_

Vacation Fund \_\_\_\_\_  
Vacation Address \_\_\_\_\_  
Vacation Sponsor \_\_\_\_\_  
Vacation Admin \_\_\_\_\_

## SUBCONTRACTORS

Attach explanation of Monies paid, copy of contract  
of billing, or other pertinent information.

**Company Name:** \_\_\_\_\_  
**Contact Person:** \_\_\_\_\_

\_\_\_\_\_  
(Address)  
\_\_\_\_\_  
(City) (State) (zipcode)

Telephone Number: \_\_\_\_\_

**Company Name:** \_\_\_\_\_  
**Contact Person:** \_\_\_\_\_

\_\_\_\_\_  
(Address)  
\_\_\_\_\_  
(City) (State) (zipcode)

Telephone Number: \_\_\_\_\_

**Company Name:** \_\_\_\_\_  
**Contact Person:** \_\_\_\_\_

\_\_\_\_\_  
(Address)  
\_\_\_\_\_  
(City) (State) (zipcode)

Telephone Number: \_\_\_\_\_

**Company Name:** \_\_\_\_\_  
**Contact Person:** \_\_\_\_\_

\_\_\_\_\_  
(Address)  
\_\_\_\_\_  
(City) (State) (zipcode)

Telephone Number: \_\_\_\_\_

# Request for Taxpayer Identification Number and Certification

Give Form to the  
requester. Do not  
send to the IRS.

▶ Go to [www.irs.gov/FormW9](http://www.irs.gov/FormW9) for instructions and the latest information.

Print or type. See Specific Instructions on page 3.	<b>1</b> Name (as shown on your income tax return). Name is required on this line; do not leave this line blank.	
	<b>2</b> Business name/disregarded entity name, if different from above	
	<b>3</b> Check appropriate box for federal tax classification of the person whose name is entered on line 1. Check only <b>one</b> of the following seven boxes. <input type="checkbox"/> Individual/sole proprietor or single-member LLC <input type="checkbox"/> Limited liability company. Enter the tax classification (C=C corporation, S=S corporation, P=Partnership) ▶ _____ <b>Note:</b> Check the appropriate box in the line above for the tax classification of the single-member owner. Do not check LLC if the LLC is classified as a single-member LLC that is disregarded from the owner unless the owner of the LLC is another LLC that is <b>not</b> disregarded from the owner for U.S. federal tax purposes. Otherwise, a single-member LLC that is disregarded from the owner should check the appropriate box for the tax classification of its owner. <input type="checkbox"/> Other (see instructions) ▶ _____	<b>4</b> Exemptions (codes apply only to certain entities, not individuals; see instructions on page 3): Exempt payee code (if any) _____ Exemption from FATCA reporting code (if any) _____ <i>(Applies to accounts maintained outside the U.S.)</i>
	<b>5</b> Address (number, street, and apt. or suite no.) See instructions.	Requester's name and address (optional)
	<b>6</b> City, state, and ZIP code	
	<b>7</b> List account number(s) here (optional)	

## Part I Taxpayer Identification Number (TIN)

Enter your TIN in the appropriate box. The TIN provided must match the name given on line 1 to avoid backup withholding. For individuals, this is generally your social security number (SSN). However, for a resident alien, sole proprietor, or disregarded entity, see the instructions for Part I, later. For other entities, it is your employer identification number (EIN). If you do not have a number, see *How to get a TIN*, later.

**Note:** If the account is in more than one name, see the instructions for line 1. Also see *What Name and Number To Give the Requester* for guidelines on whose number to enter.

<b>Social security number</b>									
				-			-		
<b>or</b>									
<b>Employer identification number</b>									
				-					

## Part II Certification

Under penalties of perjury, I certify that:

1. The number shown on this form is my correct taxpayer identification number (or I am waiting for a number to be issued to me); and
2. I am not subject to backup withholding because: (a) I am exempt from backup withholding, or (b) I have not been notified by the Internal Revenue Service (IRS) that I am subject to backup withholding as a result of a failure to report all interest or dividends, or (c) the IRS has notified me that I am no longer subject to backup withholding; and
3. I am a U.S. citizen or other U.S. person (defined below); and
4. The FATCA code(s) entered on this form (if any) indicating that I am exempt from FATCA reporting is correct.

**Certification instructions.** You must cross out item 2 above if you have been notified by the IRS that you are currently subject to backup withholding because you have failed to report all interest and dividends on your tax return. For real estate transactions, item 2 does not apply. For mortgage interest paid, acquisition or abandonment of secured property, cancellation of debt, contributions to an individual retirement arrangement (IRA), and generally, payments other than interest and dividends, you are not required to sign the certification, but you must provide your correct TIN. See the instructions for Part II, later.

<b>Sign Here</b>	Signature of U.S. person ▶	Date ▶

## General Instructions

Section references are to the Internal Revenue Code unless otherwise noted.

**Future developments.** For the latest information about developments related to Form W-9 and its instructions, such as legislation enacted after they were published, go to [www.irs.gov/FormW9](http://www.irs.gov/FormW9).

## Purpose of Form

An individual or entity (Form W-9 requester) who is required to file an information return with the IRS must obtain your correct taxpayer identification number (TIN) which may be your social security number (SSN), individual taxpayer identification number (ITIN), adoption taxpayer identification number (ATIN), or employer identification number (EIN), to report on an information return the amount paid to you, or other amount reportable on an information return. Examples of information returns include, but are not limited to, the following.

- Form 1099-INT (interest earned or paid)

- Form 1099-DIV (dividends, including those from stocks or mutual funds)
- Form 1099-MISC (various types of income, prizes, awards, or gross proceeds)
- Form 1099-B (stock or mutual fund sales and certain other transactions by brokers)
- Form 1099-S (proceeds from real estate transactions)
- Form 1099-K (merchant card and third party network transactions)
- Form 1098 (home mortgage interest), 1098-E (student loan interest), 1098-T (tuition)
- Form 1099-C (canceled debt)
- Form 1099-A (acquisition or abandonment of secured property)

Use Form W-9 only if you are a U.S. person (including a resident alien), to provide your correct TIN.

*If you do not return Form W-9 to the requester with a TIN, you might be subject to backup withholding. See What is backup withholding, later.*



By signing the filled-out form, you:

1. Certify that the TIN you are giving is correct (or you are waiting for a number to be issued),
2. Certify that you are not subject to backup withholding, or
3. Claim exemption from backup withholding if you are a U.S. exempt payee. If applicable, you are also certifying that as a U.S. person, your allocable share of any partnership income from a U.S. trade or business is not subject to the withholding tax on foreign partners' share of effectively connected income, and
4. Certify that FATCA code(s) entered on this form (if any) indicating that you are exempt from the FATCA reporting, is correct. See *What is FATCA reporting*, later, for further information.

**Note:** If you are a U.S. person and a requester gives you a form other than Form W-9 to request your TIN, you must use the requester's form if it is substantially similar to this Form W-9.

**Definition of a U.S. person.** For federal tax purposes, you are considered a U.S. person if you are:

- An individual who is a U.S. citizen or U.S. resident alien;
- A partnership, corporation, company, or association created or organized in the United States or under the laws of the United States;
- An estate (other than a foreign estate); or
- A domestic trust (as defined in Regulations section 301.7701-7).

**Special rules for partnerships.** Partnerships that conduct a trade or business in the United States are generally required to pay a withholding tax under section 1446 on any foreign partners' share of effectively connected taxable income from such business. Further, in certain cases where a Form W-9 has not been received, the rules under section 1446 require a partnership to presume that a partner is a foreign person, and pay the section 1446 withholding tax. Therefore, if you are a U.S. person that is a partner in a partnership conducting a trade or business in the United States, provide Form W-9 to the partnership to establish your U.S. status and avoid section 1446 withholding on your share of partnership income.

In the cases below, the following person must give Form W-9 to the partnership for purposes of establishing its U.S. status and avoiding withholding on its allocable share of net income from the partnership conducting a trade or business in the United States.

- In the case of a disregarded entity with a U.S. owner, the U.S. owner of the disregarded entity and not the entity;
- In the case of a grantor trust with a U.S. grantor or other U.S. owner, generally, the U.S. grantor or other U.S. owner of the grantor trust and not the trust; and
- In the case of a U.S. trust (other than a grantor trust), the U.S. trust (other than a grantor trust) and not the beneficiaries of the trust.

**Foreign person.** If you are a foreign person or the U.S. branch of a foreign bank that has elected to be treated as a U.S. person, do not use Form W-9. Instead, use the appropriate Form W-8 or Form 8233 (see Pub. 515, *Withholding of Tax on Nonresident Aliens and Foreign Entities*).

**Nonresident alien who becomes a resident alien.** Generally, only a nonresident alien individual may use the terms of a tax treaty to reduce or eliminate U.S. tax on certain types of income. However, most tax treaties contain a provision known as a "saving clause." Exceptions specified in the saving clause may permit an exemption from tax to continue for certain types of income even after the payee has otherwise become a U.S. resident alien for tax purposes.

If you are a U.S. resident alien who is relying on an exception contained in the saving clause of a tax treaty to claim an exemption from U.S. tax on certain types of income, you must attach a statement to Form W-9 that specifies the following five items.

1. The treaty country. Generally, this must be the same treaty under which you claimed exemption from tax as a nonresident alien.
2. The treaty article addressing the income.
3. The article number (or location) in the tax treaty that contains the saving clause and its exceptions.
4. The type and amount of income that qualifies for the exemption from tax.
5. Sufficient facts to justify the exemption from tax under the terms of the treaty article.

**Example.** Article 20 of the U.S.-China income tax treaty allows an exemption from tax for scholarship income received by a Chinese student temporarily present in the United States. Under U.S. law, this student will become a resident alien for tax purposes if his or her stay in the United States exceeds 5 calendar years. However, paragraph 2 of the first Protocol to the U.S.-China treaty (dated April 30, 1984) allows the provisions of Article 20 to continue to apply even after the Chinese student becomes a resident alien of the United States. A Chinese student who qualifies for this exception (under paragraph 2 of the first protocol) and is relying on this exception to claim an exemption from tax on his or her scholarship or fellowship income would attach to Form W-9 a statement that includes the information described above to support that exemption.

If you are a nonresident alien or a foreign entity, give the requester the appropriate completed Form W-8 or Form 8233.

## Backup Withholding

**What is backup withholding?** Persons making certain payments to you must under certain conditions withhold and pay to the IRS 24% of such payments. This is called "backup withholding." Payments that may be subject to backup withholding include interest, tax-exempt interest, dividends, broker and barter exchange transactions, rents, royalties, nonemployee pay, payments made in settlement of payment card and third party network transactions, and certain payments from fishing boat operators. Real estate transactions are not subject to backup withholding.

You will not be subject to backup withholding on payments you receive if you give the requester your correct TIN, make the proper certifications, and report all your taxable interest and dividends on your tax return.

**Payments you receive will be subject to backup withholding if:**

1. You do not furnish your TIN to the requester,
2. You do not certify your TIN when required (see the instructions for Part II for details),
3. The IRS tells the requester that you furnished an incorrect TIN,
4. The IRS tells you that you are subject to backup withholding because you did not report all your interest and dividends on your tax return (for reportable interest and dividends only), or
5. You do not certify to the requester that you are not subject to backup withholding under 4 above (for reportable interest and dividend accounts opened after 1983 only).

Certain payees and payments are exempt from backup withholding. See *Exempt payee code*, later, and the separate Instructions for the Requester of Form W-9 for more information.

Also see *Special rules for partnerships*, earlier.

## What is FATCA Reporting?

The Foreign Account Tax Compliance Act (FATCA) requires a participating foreign financial institution to report all United States account holders that are specified United States persons. Certain payees are exempt from FATCA reporting. See *Exemption from FATCA reporting code*, later, and the Instructions for the Requester of Form W-9 for more information.

## Updating Your Information

You must provide updated information to any person to whom you claimed to be an exempt payee if you are no longer an exempt payee and anticipate receiving reportable payments in the future from this person. For example, you may need to provide updated information if you are a C corporation that elects to be an S corporation, or if you no longer are tax exempt. In addition, you must furnish a new Form W-9 if the name or TIN changes for the account; for example, if the grantor of a grantor trust dies.

## Penalties

**Failure to furnish TIN.** If you fail to furnish your correct TIN to a requester, you are subject to a penalty of \$50 for each such failure unless your failure is due to reasonable cause and not to willful neglect.

**Civil penalty for false information with respect to withholding.** If you make a false statement with no reasonable basis that results in no backup withholding, you are subject to a \$500 penalty.

**Criminal penalty for falsifying information.** Willfully falsifying certifications or affirmations may subject you to criminal penalties including fines and/or imprisonment.

**Misuse of TINs.** If the requester discloses or uses TINs in violation of federal law, the requester may be subject to civil and criminal penalties.

## Specific Instructions

### Line 1

You must enter one of the following on this line; **do not** leave this line blank. The name should match the name on your tax return.

If this Form W-9 is for a joint account (other than an account maintained by a foreign financial institution (FFI)), list first, and then circle, the name of the person or entity whose number you entered in Part I of Form W-9. If you are providing Form W-9 to an FFI to document a joint account, each holder of the account that is a U.S. person must provide a Form W-9.

a. **Individual.** Generally, enter the name shown on your tax return. If you have changed your last name without informing the Social Security Administration (SSA) of the name change, enter your first name, the last name as shown on your social security card, and your new last name.

**Note: ITIN applicant:** Enter your individual name as it was entered on your Form W-7 application, line 1a. This should also be the same as the name you entered on the Form 1040/1040A/1040EZ you filed with your application.

b. **Sole proprietor or single-member LLC.** Enter your individual name as shown on your 1040/1040A/1040EZ on line 1. You may enter your business, trade, or “doing business as” (DBA) name on line 2.

c. **Partnership, LLC that is not a single-member LLC, C corporation, or S corporation.** Enter the entity’s name as shown on the entity’s tax return on line 1 and any business, trade, or DBA name on line 2.

d. **Other entities.** Enter your name as shown on required U.S. federal tax documents on line 1. This name should match the name shown on the charter or other legal document creating the entity. You may enter any business, trade, or DBA name on line 2.

e. **Disregarded entity.** For U.S. federal tax purposes, an entity that is disregarded as an entity separate from its owner is treated as a “disregarded entity.” See Regulations section 301.7701-2(c)(2)(iii). Enter the owner’s name on line 1. The name of the entity entered on line 1 should never be a disregarded entity. The name on line 1 should be the name shown on the income tax return on which the income should be reported. For example, if a foreign LLC that is treated as a disregarded entity for U.S. federal tax purposes has a single owner that is a U.S. person, the U.S. owner’s name is required to be provided on line 1. If the direct owner of the entity is also a disregarded entity, enter the first owner that is not disregarded for federal tax purposes. Enter the disregarded entity’s name on line 2, “Business name/disregarded entity name.” If the owner of the disregarded entity is a foreign person, the owner must complete an appropriate Form W-8 instead of a Form W-9. This is the case even if the foreign person has a U.S. TIN.

### Line 2

If you have a business name, trade name, DBA name, or disregarded entity name, you may enter it on line 2.

### Line 3

Check the appropriate box on line 3 for the U.S. federal tax classification of the person whose name is entered on line 1. Check only one box on line 3.

IF the entity/person on line 1 is a(n) . . .	THEN check the box for . . .
• Corporation	Corporation
• Individual • Sole proprietorship, or • Single-member limited liability company (LLC) owned by an individual and disregarded for U.S. federal tax purposes.	Individual/sole proprietor or single-member LLC
• LLC treated as a partnership for U.S. federal tax purposes, • LLC that has filed Form 8832 or 2553 to be taxed as a corporation, or • LLC that is disregarded as an entity separate from its owner but the owner is another LLC that is not disregarded for U.S. federal tax purposes.	Limited liability company and enter the appropriate tax classification. (P= Partnership; C= C corporation; or S= S corporation)
• Partnership	Partnership
• Trust/estate	Trust/estate

### Line 4, Exemptions

If you are exempt from backup withholding and/or FATCA reporting, enter in the appropriate space on line 4 any code(s) that may apply to you.

#### Exempt payee code.

- Generally, individuals (including sole proprietors) are not exempt from backup withholding.
- Except as provided below, corporations are exempt from backup withholding for certain payments, including interest and dividends.
- Corporations are not exempt from backup withholding for payments made in settlement of payment card or third party network transactions.
- Corporations are not exempt from backup withholding with respect to attorneys’ fees or gross proceeds paid to attorneys, and corporations that provide medical or health care services are not exempt with respect to payments reportable on Form 1099-MISC.

The following codes identify payees that are exempt from backup withholding. Enter the appropriate code in the space in line 4.

- 1—An organization exempt from tax under section 501(a), any IRA, or a custodial account under section 403(b)(7) if the account satisfies the requirements of section 401(f)(2)
- 2—The United States or any of its agencies or instrumentalities
- 3—A state, the District of Columbia, a U.S. commonwealth or possession, or any of their political subdivisions or instrumentalities
- 4—A foreign government or any of its political subdivisions, agencies, or instrumentalities
- 5—A corporation
- 6—A dealer in securities or commodities required to register in the United States, the District of Columbia, or a U.S. commonwealth or possession
- 7—A futures commission merchant registered with the Commodity Futures Trading Commission
- 8—A real estate investment trust
- 9—An entity registered at all times during the tax year under the Investment Company Act of 1940
- 10—A common trust fund operated by a bank under section 584(a)
- 11—A financial institution
- 12—A middleman known in the investment community as a nominee or custodian
- 13—A trust exempt from tax under section 664 or described in section 4947

The following chart shows types of payments that may be exempt from backup withholding. The chart applies to the exempt payees listed above, 1 through 13.

IF the payment is for . . .	THEN the payment is exempt for . . .
Interest and dividend payments	All exempt payees except for 7
Broker transactions	Exempt payees 1 through 4 and 6 through 11 and all C corporations. S corporations must not enter an exempt payee code because they are exempt only for sales of noncovered securities acquired prior to 2012.
Barter exchange transactions and patronage dividends	Exempt payees 1 through 4
Payments over \$600 required to be reported and direct sales over \$5,000 <sup>1</sup>	Generally, exempt payees 1 through 5 <sup>2</sup>
Payments made in settlement of payment card or third party network transactions	Exempt payees 1 through 4

<sup>1</sup> See Form 1099-MISC, Miscellaneous Income, and its instructions.

<sup>2</sup> However, the following payments made to a corporation and reportable on Form 1099-MISC are not exempt from backup withholding: medical and health care payments, attorneys' fees, gross proceeds paid to an attorney reportable under section 6045(f), and payments for services paid by a federal executive agency.

**Exemption from FATCA reporting code.** The following codes identify payees that are exempt from reporting under FATCA. These codes apply to persons submitting this form for accounts maintained outside of the United States by certain foreign financial institutions. Therefore, if you are only submitting this form for an account you hold in the United States, you may leave this field blank. Consult with the person requesting this form if you are uncertain if the financial institution is subject to these requirements. A requester may indicate that a code is not required by providing you with a Form W-9 with "Not Applicable" (or any similar indication) written or printed on the line for a FATCA exemption code.

A—An organization exempt from tax under section 501(a) or any individual retirement plan as defined in section 7701(a)(37)

B—The United States or any of its agencies or instrumentalities

C—A state, the District of Columbia, a U.S. commonwealth or possession, or any of their political subdivisions or instrumentalities

D—A corporation the stock of which is regularly traded on one or more established securities markets, as described in Regulations section 1.1472-1(c)(1)(i)

E—A corporation that is a member of the same expanded affiliated group as a corporation described in Regulations section 1.1472-1(c)(1)(i)

F—A dealer in securities, commodities, or derivative financial instruments (including notional principal contracts, futures, forwards, and options) that is registered as such under the laws of the United States or any state

G—A real estate investment trust

H—A regulated investment company as defined in section 851 or an entity registered at all times during the tax year under the Investment Company Act of 1940

I—A common trust fund as defined in section 584(a)

J—A bank as defined in section 581

K—A broker

L—A trust exempt from tax under section 664 or described in section 4947(a)(1)

M—A tax exempt trust under a section 403(b) plan or section 457(g) plan

**Note:** You may wish to consult with the financial institution requesting this form to determine whether the FATCA code and/or exempt payee code should be completed.

## Line 5

Enter your address (number, street, and apartment or suite number). This is where the requester of this Form W-9 will mail your information returns. If this address differs from the one the requester already has on file, write NEW at the top. If a new address is provided, there is still a chance the old address will be used until the payor changes your address in their records.

## Line 6

Enter your city, state, and ZIP code.

## Part I. Taxpayer Identification Number (TIN)

**Enter your TIN in the appropriate box.** If you are a resident alien and you do not have and are not eligible to get an SSN, your TIN is your IRS individual taxpayer identification number (ITIN). Enter it in the social security number box. If you do not have an ITIN, see *How to get a TIN* below.

If you are a sole proprietor and you have an EIN, you may enter either your SSN or EIN.

If you are a single-member LLC that is disregarded as an entity separate from its owner, enter the owner's SSN (or EIN, if the owner has one). Do not enter the disregarded entity's EIN. If the LLC is classified as a corporation or partnership, enter the entity's EIN.

**Note:** See *What Name and Number To Give the Requester*, later, for further clarification of name and TIN combinations.

**How to get a TIN.** If you do not have a TIN, apply for one immediately. To apply for an SSN, get Form SS-5, Application for a Social Security Card, from your local SSA office or get this form online at [www.SSA.gov](http://www.SSA.gov). You may also get this form by calling 1-800-772-1213. Use Form W-7, Application for IRS Individual Taxpayer Identification Number, to apply for an ITIN, or Form SS-4, Application for Employer Identification Number, to apply for an EIN. You can apply for an EIN online by accessing the IRS website at [www.irs.gov/Businesses](http://www.irs.gov/Businesses) and clicking on Employer Identification Number (EIN) under Starting a Business. Go to [www.irs.gov/Forms](http://www.irs.gov/Forms) to view, download, or print Form W-7 and/or Form SS-4. Or, you can go to [www.irs.gov/OrderForms](http://www.irs.gov/OrderForms) to place an order and have Form W-7 and/or SS-4 mailed to you within 10 business days.

If you are asked to complete Form W-9 but do not have a TIN, apply for a TIN and write "Applied For" in the space for the TIN, sign and date the form, and give it to the requester. For interest and dividend payments, and certain payments made with respect to readily tradable instruments, generally you will have 60 days to get a TIN and give it to the requester before you are subject to backup withholding on payments. The 60-day rule does not apply to other types of payments. You will be subject to backup withholding on all such payments until you provide your TIN to the requester.

**Note:** Entering "Applied For" means that you have already applied for a TIN or that you intend to apply for one soon.

**Caution:** A disregarded U.S. entity that has a foreign owner must use the appropriate Form W-8.

## Part II. Certification

To establish to the withholding agent that you are a U.S. person, or resident alien, sign Form W-9. You may be requested to sign by the withholding agent even if item 1, 4, or 5 below indicates otherwise.

For a joint account, only the person whose TIN is shown in Part I should sign (when required). In the case of a disregarded entity, the person identified on line 1 must sign. Exempt payees, see *Exempt payee code*, earlier.

**Signature requirements.** Complete the certification as indicated in items 1 through 5 below.

**1. Interest, dividend, and barter exchange accounts opened before 1984 and broker accounts considered active during 1983.**

You must give your correct TIN, but you do not have to sign the certification.

**2. Interest, dividend, broker, and barter exchange accounts opened after 1983 and broker accounts considered inactive during 1983.**

You must sign the certification or backup withholding will apply. If you are subject to backup withholding and you are merely providing your correct TIN to the requester, you must cross out item 2 in the certification before signing the form.

**3. Real estate transactions.** You must sign the certification. You may cross out item 2 of the certification.

**4. Other payments.** You must give your correct TIN, but you do not have to sign the certification unless you have been notified that you have previously given an incorrect TIN. "Other payments" include payments made in the course of the requester's trade or business for rents, royalties, goods (other than bills for merchandise), medical and health care services (including payments to corporations), payments to a nonemployee for services, payments made in settlement of payment card and third party network transactions, payments to certain fishing boat crew members and fishermen, and gross proceeds paid to attorneys (including payments to corporations).

**5. Mortgage interest paid by you, acquisition or abandonment of secured property, cancellation of debt, qualified tuition program payments (under section 529), ABLE accounts (under section 529A), IRA, Coverdell ESA, Archer MSA or HSA contributions or distributions, and pension distributions.** You must give your correct TIN, but you do not have to sign the certification.

**What Name and Number To Give the Requester**

For this type of account:	Give name and SSN of:
1. Individual	The individual
2. Two or more individuals (joint account) other than an account maintained by an FFI	The actual owner of the account or, if combined funds, the first individual on the account <sup>1</sup>
3. Two or more U.S. persons (joint account maintained by an FFI)	Each holder of the account
4. Custodial account of a minor (Uniform Gift to Minors Act)	The minor <sup>2</sup>
5. a. The usual revocable savings trust (grantor is also trustee)	The grantor-trustee <sup>1</sup>
b. So-called trust account that is not a legal or valid trust under state law	The actual owner <sup>1</sup>
6. Sole proprietorship or disregarded entity owned by an individual	The owner <sup>3</sup>
7. Grantor trust filing under Optional Form 1099 Filing Method 1 (see Regulations section 1.671-4(b)(2)(i)(A))	The grantor*
For this type of account:	Give name and EIN of:
8. Disregarded entity not owned by an individual	The owner
9. A valid trust, estate, or pension trust	Legal entity <sup>4</sup>
10. Corporation or LLC electing corporate status on Form 8832 or Form 2553	The corporation
11. Association, club, religious, charitable, educational, or other tax-exempt organization	The organization
12. Partnership or multi-member LLC	The partnership
13. A broker or registered nominee	The broker or nominee

For this type of account:	Give name and EIN of:
14. Account with the Department of Agriculture in the name of a public entity (such as a state or local government, school district, or prison) that receives agricultural program payments	The public entity
15. Grantor trust filing under the Form 1041 Filing Method or the Optional Form 1099 Filing Method 2 (see Regulations section 1.671-4(b)(2)(i)(B))	The trust

<sup>1</sup> List first and circle the name of the person whose number you furnish. If only one person on a joint account has an SSN, that person's number must be furnished.

<sup>2</sup> Circle the minor's name and furnish the minor's SSN.

<sup>3</sup> You must show your individual name and you may also enter your business or DBA name on the "Business name/disregarded entity" name line. You may use either your SSN or EIN (if you have one), but the IRS encourages you to use your SSN.

<sup>4</sup> List first and circle the name of the trust, estate, or pension trust. (Do not furnish the TIN of the personal representative or trustee unless the legal entity itself is not designated in the account title.) Also see *Special rules for partnerships*, earlier.

\*Note: The grantor also must provide a Form W-9 to trustee of trust.

Note: If no name is circled when more than one name is listed, the number will be considered to be that of the first name listed.

**Secure Your Tax Records From Identity Theft**

Identity theft occurs when someone uses your personal information such as your name, SSN, or other identifying information, without your permission, to commit fraud or other crimes. An identity thief may use your SSN to get a job or may file a tax return using your SSN to receive a refund.

To reduce your risk:

- Protect your SSN,
- Ensure your employer is protecting your SSN, and
- Be careful when choosing a tax preparer.

If your tax records are affected by identity theft and you receive a notice from the IRS, respond right away to the name and phone number printed on the IRS notice or letter.

If your tax records are not currently affected by identity theft but you think you are at risk due to a lost or stolen purse or wallet, questionable credit card activity or credit report, contact the IRS Identity Theft Hotline at 1-800-908-4490 or submit Form 14039.

For more information, see Pub. 5027, Identity Theft Information for Taxpayers.

Victims of identity theft who are experiencing economic harm or a systemic problem, or are seeking help in resolving tax problems that have not been resolved through normal channels, may be eligible for Taxpayer Advocate Service (TAS) assistance. You can reach TAS by calling the TAS toll-free case intake line at 1-877-777-4778 or TTY/TDD 1-800-829-4059.

**Protect yourself from suspicious emails or phishing schemes.**

Phishing is the creation and use of email and websites designed to mimic legitimate business emails and websites. The most common act is sending an email to a user falsely claiming to be an established legitimate enterprise in an attempt to scam the user into surrendering private information that will be used for identity theft.

The IRS does not initiate contacts with taxpayers via emails. Also, the IRS does not request personal detailed information through email or ask taxpayers for the PIN numbers, passwords, or similar secret access information for their credit card, bank, or other financial accounts.

If you receive an unsolicited email claiming to be from the IRS, forward this message to [phishing@irs.gov](mailto:phishing@irs.gov). You may also report misuse of the IRS name, logo, or other IRS property to the Treasury Inspector General for Tax Administration (TIGTA) at 1-800-366-4484. You can forward suspicious emails to the Federal Trade Commission at [spam@uce.gov](mailto:spam@uce.gov) or report them at [www.ftc.gov/complaint](http://www.ftc.gov/complaint). You can contact the FTC at [www.ftc.gov/idtheft](http://www.ftc.gov/idtheft) or 877-IDTHEFT (877-438-4338). If you have been the victim of identity theft, see [www.IdentityTheft.gov](http://www.IdentityTheft.gov) and Pub. 5027.

Visit [www.irs.gov/IdentityTheft](http://www.irs.gov/IdentityTheft) to learn more about identity theft and how to reduce your risk.

## Privacy Act Notice

Section 6109 of the Internal Revenue Code requires you to provide your correct TIN to persons (including federal agencies) who are required to file information returns with the IRS to report interest, dividends, or certain other income paid to you; mortgage interest you paid; the acquisition or abandonment of secured property; the cancellation of debt; or contributions you made to an IRA, Archer MSA, or HSA. The person collecting this form uses the information on the form to file information returns with the IRS, reporting the above information. Routine uses of this information include giving it to the Department of Justice for civil and criminal litigation and to cities, states, the District of Columbia, and U.S. commonwealths and possessions for use in administering their laws. The information also may be disclosed to other countries under a treaty, to federal and state agencies to enforce civil and criminal laws, or to federal law enforcement and intelligence agencies to combat terrorism. You must provide your TIN whether or not you are required to file a tax return. Under section 3406, payers must generally withhold a percentage of taxable interest, dividend, and certain other payments to a payee who does not give a TIN to the payer. Certain penalties may also apply for providing false or fraudulent information.

*A complete copy of AIA Document A201, 1997 Edition, with Supplementary General Conditions incorporated, is available for review in the Peoria Park District's Planning, Design and Construction Office.*

## SUPPLEMENTARY GENERAL CONDITIONS

1. A. **"GENERAL CONDITIONS OF THE CONTRACT FOR CONSTRUCTION"**, AIA Document A201, 1997 Edition, published by the American Institute of Architects, including revisions adopted before the date of the Project Manual, is hereby made part of these Specifications with same force and effect as though set forth in full.
  - B. The following modifies, changes, deletes from or adds to the General Conditions of the Contract for Construction (AIA Document A201, Fourteenth Edition, 1997). Where any Article of the General Conditions is modified or any Paragraph, Subparagraph or Clause thereof is modified or deleted by these Supplementary Conditions, the unaltered provisions of that Article, Paragraph, Subparagraph or Clause shall remain in effect.
  - C. Parenthesis ( ) indicates the appropriate section and Subparagraph of the General Conditions which each paragraph of the Supplementary General Conditions modifies or refers to.
2. **INSERT THE FOLLOWING PHRASE TO PARAGRAPH (1.1.1) AFTER THE WORDS "The Contract Documents consist of the Agreement Between Owner and Contractor (hereinafter the Agreement)":**

“the Contractor's Bid, the Advertisement for Bids, the Instructions to Bidders, sample forms and addenda relating to these,”

**DELETE THE LAST SENTENCE OF PARAGRAPH (1.1.1).**

3. **ADD THE FOLLOWING SENTENCES TO END OF PARAGRAPH (1.2.1):**

The Contractor shall notify the Owner's Representative immediately if discrepancies are discovered. Full-size or large-scale details or drawings shall govern small-scale drawings that the former are intended to amplify. Dimensions from drawings shall not be determined by scale or rule. Where the Drawings and Specifications conflict with each other or with themselves, the Owner's Representative (in consultation with the Architect, if any) will decide which conflicting requirement governs. Should discrepancies or doubt occur, Contractor shall not proceed with the Work without clarification from the Owner. Contractor shall request clarification in a reasonable time to avoid delays and increases in the Contract Sum.

**ADD THE FOLLOWING PARAGRAPHS TO SECTION (1.2):**

**1.2.4** If any item or material shown on the Drawings is omitted from the Specifications, or vice-versa (except when the Drawings and Specifications clearly exclude such omitted item), and when such item or material is clearly required to complete the detail shown or specified, the Contractor shall furnish and install such item or material of the type and quality established by the balance of the detail shown and specified at no increase to the Contract Sum.

**1.2.5** Where a typical or representative detail is shown on the Drawings, this detail shall constitute the standard for workmanship and materials throughout those parts of the Work.

**1.2.6** Any Summary of Work as outlined in the Specifications shall not be deemed to limit the work required by the Contract Documents. The Contractor and each Subcontractor shall be responsible for carefully examining all Drawings, including all details, plans, elevations, sections, schedules and diagrams for each particular type of work, and for coordinating the Work described in the Drawings, with the related Specifications. The Contractor shall also be responsible for determining the exact scope of work for each type of work per the Contract Documents and Contractor shall endeavor to check cross-references of work excluded from any division. The Contract Sum is deemed to be based on a complete installation. When additional details or instructions are clearly required to complete the work, the Contractor is deemed to have made an allowance in the Contract Sum for completion of such Work consistent with the local standard of care.

**1.2.7** The Drawings are intended to show the arrangement, design and extent of the Work and are schematic in nature. They are not to be scaled for roughing-in measurements or used as shop drawings.

**4. ADD THE FOLLOWING PARAGRAPH TO SECTION (1.5):**

**1.5.3** Neither any oral representation by or oral agreement with any officer, agent, or employee of Owner or Architect before execution of this Contract shall affect or modify any of the Contractor's rights or obligations hereunder. Contractor is not aware of any facts that make misleading or inaccurate in any material respect any information Owner or Architect has furnished to Contractor which would have a material adverse affect on the Contract Time or Contract Sum which Contractor has not advised Owner or Architect of, and if, during the course of the performance of the Work, Contractor learns of any such facts it will so advise Owner. Contractor shall not be entitled to any adjustments in the Contract Time or the Contract Sum as a consequence of Contractor's breach of the terms of this Subparagraph.

**5. IN PARAGRAPH (1.6.1) DELETE THE WORD "Architect" IN THE FOURTH SENTENCE AND REPLACE IT WITH THE WORD "Owner".**

**DELETE SENTENCES #7, #8, #9 STARTING WITH "The Contractor, Subcontractors, Sub-subcontractors and material or equipment suppliers are ...."**

**6. DELETE PARAGRAPH (2.2.3) IN ITS ENTIRETY.**

**7. ADD THE FOLLOWING SENTENCE AT THE END OF PARAGRAPH (2.3.1):**

"The Owner shall not be liable for any extra cost incurred by the Contractor by such an order."

**8. IN PARAGRAPH (2.4.1) DELETE THE SECOND TO LAST SENTENCE.**

**9. IN PARAGRAPH (3.2.1, 3.2.2 AND 3.2.3) AFTER THE WORD "Architect" ADD THE WORDS "and Owner".**

**10. ADD THE FOLLOWING PARAGRAPHS TO SECTION (3.2):**

**3.2.4** Before starting any work, the Contractor shall examine work performed by others to which his work adjoins or is applied to and report to the Owner's Representative any conditions that will prevent the satisfactory accomplishment of his work. Failure to notify the Owner's Representative of deficiencies or faults in preceding work prior to commencing work shall constitute acceptance thereof and waiver of any claim of its unsuitability.

**11. ADD THE FOLLOWING PARAGRAPHS TO SECTION (3.4):**

**3.4.4** Before ordering any material or doing any Work, the Contractor shall verify all measurements at the Project site and he shall be responsible for the correctness of same. No extra charge or compensation will be allowed to the Contractor on account of any difference between actual dimensions and the measurements shown on the Project Drawings.

**3.4.5** The Contractor shall carefully inspect all materials delivered on and to the Project site and reject defective materials without waiting for the Owner's Representative or other representative of Owner to observe the materials.

**12. ADD THE FOLLOWING PARAGRAPHS TO SECTION (3.5):**

**3.5.2** The Contractor agrees to assign to the Owner any and all manufacturer's warranties relating to materials and equipment furnished as part of the Work and further agrees to perform the Work in such manner so as to preserve any and all such manufacturer's warranties subject to installation directives and other terms of the Contract Documents. The Contractor agrees to deliver to the Owner, upon final payment, such assignments along with or as part of a reference manual, in form and detail reasonably acceptable to Owner, showing all such warranties and guarantees provided by the Contractor and Subcontractors. Such warranties and guarantees shall commence no sooner than the date of purchase from the supplier.

**3.5.3** The warranty of Contractor provided in Paragraph 3.5 shall in no way limit or abridge the warranties of the suppliers of equipment and systems which are to comprise a portion of the Work, if they are broader, and all of such warranties shall be in form and substance as required by the Contract Documents. Contractor shall take no action or fail to act in any way which results in the termination or expiration of such third party warranties or which otherwise results in prejudice to the rights of the Owner under such warranties subject to installation directives and other terms of the Contract Documents. Contractor agrees to provide all notices required for the effectiveness of such warranties and shall include provisions in the contracts with the providers and manufacturers of such systems and equipment whereby Owner shall have a direct right of enforcement of such warranty obligations.

**13. IN PARAGRAPH (3.6.1), DELETE THE WORD "Sales".**

**ADD THE FOLLOWING AT THE END OF PARAGRAPH (3.6.1):**

The Peoria Park District is exempt from Federal, State and Local taxes. A certificate of exemption will be furnished upon request.

**14. IN PARAGRAPH (3.10.2) BEFORE THE WORD "Architect's" ADD THE WORDS "Owner's and".**

**IN PARAGRAPH (3.10.2) AFTER THE WORD "Architect" ADD THE WORDS "and Owner's Representative".**

**ADD THE FOLLOWING PARAGRAPHS TO SECTION (3.10):**

**3.10.4** The construction schedule shall provide for the most expeditious and practicable execution of the Work. The Contractor shall also work closely with the Owner to confirm that the construction schedule accurately reflects the status of the Project. The Contractor's construction schedule shall be updated every month by the Contractor and submitted to the Owner.



- .1 Whenever it becomes apparent from the updated construction schedule that any substantial completion previously established by the construction schedule cannot be met, the Contractor shall, at the Owner's request, take any or all of the following actions with no increase to the Contract Sum or Contract Time (unless the delay is caused by an event set forth in paragraph 8.3 of these General Conditions thereby permitting adjustment of the Contract Sum and/or Contract Time under Paragraph 4.3.5 of these General Conditions):

- .1.1 Increase construction manpower to substantially return the Project to schedule;
- .1.2 Increase the number of working hours per shift, shifts per day or the amount of construction equipment or any combination of the foregoing which will substantially return the Project to schedule;
- .1.3 Reschedule activities to concurrently accomplish activities, to the maximum degree practicable, in the time required by the Contract Documents.

If the Contractor fails to take any of these actions Owner shall have the notice and other rights set forth in Paragraph 2.4.

**15. IN PARAGRAPH (4.1.1) DELETE THE FIRST SENTENCE AND SUBSTITUTE THE FOLLOWING:**

"The Architect, Owner's Representative, and Owner's Project Manager are defined in Paragraph C of "Section 01000 - General" of "Division 01000 - General Requirements".

16. **IN PARAGRAPH (4.2.1) DELETE THE WORDS “and will be an Owner’s Representative”.**
17. **IN PARAGRAPH (4.2.2) DELETE THE WORDS “as a representative of the Owner”.**
18. **IN PARAGRAPH (4.2.4) IN THE FIRST SENTENCE SUBSTITUTE THE WORD “Architect” FOR THE WORD “Owner” AND SUBSTITUTE THE WORD “Owner” FOR THE WORD “Architect”.**
19. **IN PARAGRAPH (4.2.5) DELETE THE WORD “Architect’s” AND “Architect” AND SUBSTITUTE THE WORDS “Owner Representative’s” AND “Owner Representative”.**
20. **IN PARAGRAPH (4.2.6) IN THE SECOND SENTENCE AFTER THE WORDS “will have authority” INSERT THE WORDS “upon written authorization from the Owner”.**
21. **IN PARAGRAPH (4.2.8) DELETE THE WORD “prepare” AND SUBSTITUTE THE WORDS “assist the Owner’s Representative in preparing”.**
22. **IN PARAGRAPH (4.2.9) DELETE THE WORD “Architect” AND SUBSTITUTE WORDS “Owner’s Representative, assisted by the Architect”.**
23. **IN PARAGRAPH (4.2.11) IN THE FIRST SENTENCE DELETE THE WORDS “and decide”.**
24. **IN PARAGRAPH (4.2.12) IN THE FIRST SENTENCE DELETE THE WORD “and decisions”.**  
**IN PARAGRAPH (4.2.12) IN THE SECOND SENTENCE DELETE THE WORDS “and initial decisions” AND “or decisions”.**
25. **ADD PARAGRAPH TO SECTION (4.2):**

**4.2.14** Notwithstanding any other provision of this Agreement to the contrary, the Architect shall have no authority to order or approve any material deviation from the Contract Documents, whether or not such deviation affects the Contract Sum or other Substantial Completion Date (as defined herein). In the event any such deviation is sought, prior written approval from the Owner’s Representative and the Owner must be obtained. The Architect may decide quality issues and may approve non-material deviations from the Contract Documents.

**26. IN PARAGRAPH (4.3.4) IN THE FOURTH SENTENCE DELETE THE WORD “decision” AND SUBSTITUTE THE WORD “recommendation”.**

**IN PARAGRAPH (4.3.4) IN THE LAST SENTENCE DELETE THE WORD “determination” AND SUBSTITUTE THE WORD “recommendation”.**

**27. DELETE PARAGRAPH (4.3.10) IN ITS ENTIRETY.**

**28. DELETE PARAGRAPH (4.4.1) AND SUBSTITUTE THE FOLLOWING:**

“Claims, disputes and other matters in question between the Contractor and the Owner relating to the execution or progress of the Work or the interpretation of the Contract Documents shall be initially referred in writing to the Architect for a recommendation.”

**29. IN PARAGRAPH (4.4.2) AFTER “(2)” ADD THE WORD “recommend” AND CHANGE THE WORD “reject” TO “rejecting”.**

**IN PARAGRAPH (4.4.2) AFTER “(3)” ADD THE WORD “recommend” AND CHANGE THE WORD “approve” TO “approving”.**

**IN PARAGRAPH (4.4.2) AT THE END OF THE SENTENCE DELETE THE WORD “resolve” AND ADD THE WORDS “make recommendation on”.**

**30. IN PARAGRAPH (4.4.3) DELETE THE WORD “decision” AND SUBSTITUTE THE WORD “recommendation”.**

**31. IN PARAGRAPH (4.4.4) IN THE LAST SENTENCE DELETE THE WORDS “either reject or approve the Claim” AND SUBSTITUTE THE WORDS “provide a recommendation regarding the Claim in accordance with Paragraph 4.2.2”.**

**IN PARAGRAPH (4.4.4) AT THE END OF THE LAST SENTENCE DELETE THE WORDS “in whole or in part.”**

**32. DELETE PARAGRAPHS (4.4.5) AND (4.4.6) IN THEIR ENTIRETY.**

**33. IN PARAGRAPH (4.4.8) DELETE THE WORD “resolution” AND SUBSTITUTE THE WORDS “final recommendation”.**

**IN PARAGRAPH (4.4.8) AFTER THE WORD “Architect,” ADD THE WORD “or”.**

**IN PARAGRAPH (4.4.8) AT THE END OF THE SENTENCE DELETE THE WORDS “or by arbitration”.**

**34. IN PARAGRAPH (4.5.1) DELETE THE WORD “decision” AND SUBSTITUTE THE WORD “recommendation”.**

**IN PARAGRAPH (4.5.1) DELETE THE WORDS “arbitration or”.**

**35. IN PARAGRAPH (4.5.2) IN THE SECOND SENTENCE DELETE THE WORDS “a demand for arbitration” AND SUBSTITUTE THE WORDS “legal or equitable proceedings”.**

**IN PARAGRAPH (4.5.2) AFTER THE WORDS “proceed in advance of“ DELETE THE WORDS “arbitration or”.**

**36. IN PARAGRAPH (4.5.3) DELETE THE FIRST SENTENCE.**

**37. DELETE SECTION (4.6) IN ITS ENTIRETY.**

**38. IN PARAGRAPH (5.2.1) DELETE THE FIRST SENTENCE AND SUBSTITUTE:**

“The subcontractors/suppliers listed by the Contractor on the Major Subcontractor/Supplier List (submitted with the Bid) shall not be changed without the written consent of the Owner.”

**IN PARAGRAPH (5.2.1) IN THE SECOND SENTENCE DELETE THE WORDS “Architect will” AND SUBSTITUTE THE WORDS “Owner’s Representative will”.**

**IN PARAGRAPH (5.2.1) IN THE SECOND SENTENCE AFTER THE WORDS “promptly reply to” ADD THE WORDS “any request made by”.**

**IN PARAGRAPH (5.2.1) IN THE SECOND SENTENCE AFTER THE WORDS “any such proposed” ADD THE WORDS “change in”.**

**IN PARAGRAPH (5.2.1) IN THE LAST SENTENCE DELETE THE WORDS “Owner or Architect” AND SUBSTITUTE THE WORDS “Owner’s Representative”.**

**IN PARAGRAPH (5.2.1) IN THE LAST SENTENCE DELETE THE WORD “promptly” AND ADD THE WORDS “within 10 calendar days (of receipt of written request for such change from the Contractor)”.**

**39. IN PARAGRAPH (6.2.2) BEFORE THE WORD “Architect” ADD THE WORDS “Owner and”.**

**40. IN PARAGRAPH (6.3.1) DELETE THE WORD “Architect” AND SUBSTITUTE THE WORD “Owner”.**

**41. IN PARAGRAPH (7.2.1) DELETE THE WORDS “the Architect” AND SUBSTITUTE THE WORDS “the Owner’s Representative”.**

**ADD THE FOLLOWING PARAGRAPHS TO SECTION (7.2):**

**7.2.3** A Change Order shall include all of the Contractor’s costs associated therewith.

**7.2.4** The Contractor shall not accept any request for a Change Order from any person other than the Owner and may not perform any work asserted to constitute a change in the Work until the Owner has approved the Change Order in writing, unless the Owner authorizes the Contractor, in writing, to proceed with a change prior to the Owner's final approval. Notwithstanding anything to the contrary herein, the Contractor shall not charge for overtime services in the performance of any Change Order Work, unless the Owner has specifically authorized overtime in writing. Owner may competitively bid changes in the Work and Contractor, Subcontractor and suppliers shall provide Owner with all documents Owner requests to facilitate such competitive bidding of changes in the Work.

**7.2.5** There shall be no change in the Work, whether an alteration or addition to the Contract Sum or to any amounts due under the Contract Documents or to a change in the Contract Time, unless and until such alteration or addition has been authorized by a written Change Order executed and issued in accordance and compliance with the requirements with this Article 7 or by written authorization to proceed with such change in the Work signed by the Owner or as otherwise provided pursuant to the Contract Documents. The requirements set forth in this Paragraph 7.2.5 are of the essence. No claim that the Owner has been unjustly enriched by any alteration or addition to the Work, whether or not any such unjust enrichment to the Work or to the Owner in fact exists, shall form the basis of any claim for an increase in any amount due under the Contract Documents or a change in the Contract Time, and the terms of a fully-executed Change Order shall be conclusive.

- 42. IN PARAGRAPH (7.3.1) DELETE THE WORDS "the Architect" AND SUBSTITUTE THE WORDS "the Owner's Representative".**
- 43. IN PARAGRAPH (7.3.4) DELETE THE WORDS "the Architect" AND SUBSTITUTE THE WORDS "the Owner's Representative".**
- 44. IN PARAGRAPH (7.3.6) IN THE FIRST SENTENCE DELETE THE WORD "determined" AND SUBSTITUTE THE WORD "recommended".**
- 45. IN PARAGRAPH (7.3.7) IN THE FIRST SENTENCE AFTER THE WORD "Architect" ADD THE WORDS "and the Owner's Representative".**
- 46. IN PARAGRAPH (7.3.8) DELETE THE WORDS "the Architect" AND SUBSTITUTE THE WORDS "the Owner's Representative".**
- 47. IN PARAGRAPH (7.3.9) DELETE THE WORD "determination" AND SUBSTITUTE THE WORD "recommendation".**
- 48. IN PARAGRAPH (8.1.3) DELETE THE WORD "Architect" AND SUBSTITUTE THE WORDS "Owner's Representative".**
- 49. ADD THE FOLLOWING PARAGRAPHS TO SECTION (8.2).**

**8.2.4** All work shall be "Substantially Complete" as required by the **Instructions to Bidders** and the **Agreement Between Owner and Contractor**.

**8.2.5** It is further agreed that said completion schedule is reasonable, and the Contractor shall prosecute said work regularly, diligently and continuously at such rate of progress as will insure full completion thereof within the time specified.

**8.2.6** Provided, however, the following exceptions:

- .1 Any preference, priority or allocation order duly issued by the United States Government.
- .2 Any unforeseeable cause beyond the control and without the fault or negligence of the Contractor, including acts of God, or of a public enemy, acts of the Owner, acts of another Contractor in performance of a separate contract with the Owner, fire, floods, epidemics, quarantine restrictions, strikes, freight embargoes and unusually severe weather. The criteria on which the unusually severe weather shall be based is the average precipitation/temperatures received in the project area, as recorded over a period of the last five (5) years at the local area United States Weather Station. Any extension of time due to unusually severe weather must be requested by the Contractor on the basis of documented records of the actual precipitation/temperatures during the contract time period, compared with the normal/average for the area. Also, the criteria shall include the number of excessive precipitation or extreme cold days (i.e., days in which the temperature would adversely affect the type of work being constructed) over the same period and whether or not the Contractor's force worked on said days or stage of construction was affected.
- .3 Any delays of subcontractors occasioned by any of the causes specified in this paragraph.

8.2.7 Provided further that the Contractor shall, within seven (7) days from the beginning of any such delay during the performance of the Contract, notify the Owner's Representative in writing of the alleged cause of such delay.

**50. IN PARAGRAPH (8.3.1) DELETE THE WORDS “and arbitration”.**

**IN PARAGRAPH (8.3.1) DELETE THE WORD “determine” AND SUBSTITUTE THE WORD “recommend”.**

**51. DELETE PARAGRAPH (9.2.1) AND SUBSTITUTE THE FOLLOWING:**

“Before the first Application for Payment, the Contractor shall submit to the Owner’s Representative a schedule of values allocated to various portions of the Work, prepared in such form and supported by such data to substantiate its accuracy as the Architect and Owner’s Representative may require. This schedule, unless objected to by the Architect and Owner’s Representative, shall be used as a basis for reviewing the Contractor’s Applications for Payment.”

**52. IN THE FIRST SENTENCE OF (9.3.1), CHANGE "ten" TO "forty five”.**

**IN PARAGRAPH (9.3.1) IN THE FIRST SENTENCE DELETE THE WORD “Architect” AND SUBSTITUTE THE WORDS “Owner’s Representative”.**

**ADD THE FOLLOWING TO THE END OF PARAGRAPH (9.3.1):**

Payment requests shall consist of AIA Documents #702 "Application and Certificate for Payment"; AIA #703 "Continuation Sheet"; Contractors Affidavit of Payment to Subcontractors and Suppliers; Weekly Workforce Reports; Certified Payroll Form; and Waivers of Lien. (Waivers of Lien are required from the general contractor in the full amount of the current payment application, and from all subcontractors, suppliers, or workers who provide more than \$10,000 of project material/labor of the Work. The waiver shall be in the amount(s) listed in the Contractor's Affidavit.) For final payment, the general contractor shall also provide a Waiver of Lien in the full amount of the contract price.

**The Waiver of Lien and Contractor Affidavit forms used shall be the Peoria Park District's standard form(s): 1) "Final Waiver of Lien" (for general contractors), 2) "Waiver of Lien - General**

Contractor's Partial To Cover Only Certain Payments", 3) "Sub-Contractor's Final Waiver of Lien", 4) "Waiver of Lien - Sub-Contractor's Partial To Cover Only Certain Payments, and 5) "Contractor's Affidavit". (These forms are included in the Project Manual, and are the required Waiver of Lien forms for the project.)

(If the Contractor is unable to provide the required sub-contractor waiver at the time the application for payment is submitted (preferred method) alternatively, it may be provided at the time that payment is delivered by the District. If the sub-contractor waiver(s) still cannot be provided at that time, the District will provide "two-party" checks in which the Contractor and the sub-contractor are named jointly as payees.)

Format of AIA #703 shall follow that of "Schedule of Values". (See Division 01000 Article IV.) All payment requests shall reflect retainage in the amount of 10% of completed work.

**53. IN PARAGRAPH (9.3.1.1) DELETE THE WORDS “or by interim determination of the Architect, but not yet included in Change Orders”.**

**54. ADD THE FOLLOWING SUB-PARAGRAPHS TO PARAGRAPH (9.3.1):**

**9.3.1.3** Upon Substantial Completion, the Owner will pay 95% percent of the amount due to the Contractor on account.

**9.3.1.4** Monthly progress payments will be made by the Owner on projects lasting more than sixty days (from award of the bid to the Substantial Completion date given in the Supplementary Instructions to Bidders).

**55. ADD THE FOLLOWING SUB-PARAGRAPHS TO PARAGRAPH (9.3.2):**

**9.3.2.1** Material stored on site will be considered for payment only when a Schedule of Stored Materials with appropriate values accompany the payment request as an attachment.

**9.3.2.2** All material and work covered by partial payments made shall thereupon become the sole property of the Owner, but this provision shall not be construed as relieving the Contractor from the sole responsibility for the care and protection of material and work upon which payments have been made or the restoration of any damaged work, or as a waiver of the contract.

**56. IN PARAGRAPH (9.4.1) DELETE THE WORDS “Architect” AND “Architect’s” AND SUBSTITUTE THE WORDS “Owner’s Representative” AND “Owner’s Representative’s”.**

**IN PARAGRAPH (9.4.1) DELETE THE PHRASE "with a copy to the Contractor".**

**57. IN THE FIRST SENTENCE OF PARAGRAPH (9.4.2) DELETE THE WORD “Architect”.**

**IN THE FIRST SENTENCE OF PARAGRAPH (9.4.2) AFTER THE WORDS “Architect’s” ADD THE WORDS “and Owner’s Representative’s”.**

**IN THE FOURTH SENTENCE OF PARAGRAPH (9.4.2) DELETE THE WORDS “Architect has” AND SUBSTITUTE THE WORDS “Owner’s Representative and Architect have”.**

**58. IN PARAGRAPH (9.5.1) DELETE THE WORDS “Architect” AND “Architect’s” AND SUBSTITUTE THE WORDS “Owner’s Representative AND “Owner’s Representative’s”.**

- 59. IN PARAGRAPHS (9.6.1, 9.6.3, AND 9.6.4) DELETE THE WORDS “Architect” AND SUBSTITUTE THE WORDS “Owner’s Representative”.**
- 60. IN PARAGRAPH (9.7.1) DELETE THE WORD “Architect” AND SUBSTITUTE THE WORDS “Owner’s Representative”.**
- IN PARAGRAPH (9.7.1) DELETE THE WORDS “or awarded by arbitration”.**
- 61. IN PARAGRAPH (9.8.2) DELETE THE WORD “Architect” AND SUBSTITUTE THE WORDS “Owner’s Representative”.**
- 62. IN THE FIRST SENTENCE OF PARAGRAPH (9.8.3) DELETE THE WORD “Architect” AND SUBSTITUTE THE WORDS “Owner’s Representative assisted by the Architect”.**
- IN THE SECOND AND THIRD SENTENCES OF PARAGRAPH (9.8.3) DELETE THE WORDS “Architect’s” and “Architect” AND SUBSTITUTE THE WORDS “Owner’s Representative’s” and “Owner’s Representative”.**
- 63. IN PARAGRAPH (9.8.4) DELETE THE WORD “Architect” AND SUBSTITUTE THE WORDS “Owner’s Representative”.**
- 64. IN PARAGRAPH (9.9.1) DELETE THE WORD “Architect” AND SUBSTITUTE THE WORDS “Owner’s Representative”.**
- 65. IN PARAGRAPH (9.10.1) IN THE FIRST SENTENCE AFTER THE FIRST TWO APPEARANCES OF THE WORD ‘Architect’ ADD THE WORDS “and Owner’s Representative”.**
- IN PARAGRAPH (9.10.1) DELETE THE THIRD AND FOURTH APPEARANCES OF THE WORD “Architect” and “Architect’s” AND SUBSTITUTE THE WORDS “Owner’s Representative” and “Owner’s Representative’s”.**
- IN PARAGRAPH (9.10.1) AFTER THE FIFTH APPEARANCE OF THE WORD “Architect’s” ADD THE WORDS “and Owner’s Representative’s”.**
- IN THE LAST SENTENCE OF PARAGRAPH (9.10.1) DELETE THE WORD “Architect’s” AND SUBSTITUTE THE WORDS “Owner’s Representative’s”.**
- 66. IN PARAGRAPH (9.10.2) DELETE THE WORD “Architect” AND SUBSTITUTE THE WORD “Owner’s Representative”.**
- 67. ADD THE FOLLOWING SUB-PARAGRAPH TO PARAGRAPH (9.10.2):**
- 9.10.2.1** When all items including items noted within Division 1000 General Requirements are found to be complete and in conformance with the Contract Documents, a final payment will be issued.
- 68. IN PARAGRAPH (9.10.3) DELETE THE WORD “Architect” AND SUBSTITUTE THE WORDS “Owner’s Representative”.**
- 69. IN PARAGRAPH (11.1.1) IN THE FIRST SENTENCE AFTER THE PHRASE “as will protect the Contractor” ADD THE WORDS “Architect and Owner”.**

- 70. IN PARAGRAPH (11.1.2), IN THE FIRST SENTENCE DELETE THE WORDS “limits of liability specified in the Contract Documents” AND SUBSTITUTE THE WORDS “limits required in ‘Attachment A – Project Specific Insurance Requirements’ (which is included as the last section of the Project Manual and the requirements therein shall be made part of the Contract Documents).”.**

**IN PARAGRAPH (11.1.2) AFTER THE FIRST SENTENCE ADD:**

“In addition, if any of the work occurs within fifty feet of an active railroad line and the Contractor’s general liability coverages provide for exclusions of coverage when working on or near a railroad, the Contractor shall provide a separate Railroad Protective Liability Insurance Policy naming the railroad as the insured party, with the coverage limits required by that railroad.”

- 71. IN PARAGRAPH (11.1.3), AFTER THE WORDS “Certificates of insurance” ADD THE WORDS “and endorsements to the insurance policy(s) which are”.**

**IN PARAGRAPH (11.1.3) AFTER THE WORDS “acceptable to the Owner” ADD THE WORDS “and naming the Owner, their agents and consultants as additional insured”.**

**ADD THE FOLLOWING SUB-PARAGRAPHS TO PARAGRAPH (11.1)**

**11.1.4** The Contractor may, at his option, furnish Owner’s Protective Liability Insurance in lieu of naming the Owner Additional Insured on the Contractor’s policy, as required above. This insurance shall protect the Owner from claims as set forth in Paragraph 11.1.1 of the General Conditions, and to the limits required herein, as shown in “Attachment A”.

**11.1.5** The Contractor shall furnish two copies of each of the required Certificates or Endorsements for each copy of the Agreement which shall specifically set forth evidence of all coverage required by the Contract Documents. The form of the Certificate(s) or Endorsement(s) shall be those as required in “Attachment A”. The Contractor shall also furnish to the Owner copies of any endorsements which limit coverage, or are subsequently issued amending coverage or limits of coverage.

- 72. DELETE PARAGRAPHS (11.3.1, 11.3.2, AND 11.3.3) IN THEIR ENTIRETY.**

- 73. DELETE PARAGRAPH (11.4.1) AND SUBSTITUTE:**

“If the work of the project is being completed by one general or prime contractor rather than multiple prime contractors, the Contractor shall purchase and maintain property insurance upon the entire Work at the site to the full replacement value thereof. Such insurance shall be in a company or companies against which the Owner has no reasonable objection. This insurance shall include the interests of the Owner, the Contractor, Subcontractors and Sub-subcontractors in the Work.

- 74. AT THE END OF PARAGRAPH (11.4.1.1) ADD THE FOLLOWING SENTENCE: “The form of policy for this coverage shall be “Completed Value”.**

- 75. DELETE PARAGRAPH (11.4.1.2) IN ITS ENTIRETY.**



**76. DELETE PARAGRAPH (11.4.1.3) IN ITS ENTIRETY AND SUBSTITUTE:**

“If by the terms of this insurance any mandatory deductibles are required, or if the Contractor should elect, with the concurrence of the Owner, to increase the mandatory deductible amounts or purchase this insurance with voluntary deductible amounts, the Contractor shall be responsible for payment of the amount of all deductibles in the event of a paid claim. If separate contractors are added as insureds to be covered by this policy, the separate contractors shall be responsible for payment of appropriate part of any deductibles in the event claims are paid on their part of the Project.”

**77. DELETE PARAGRAPHS (11.4.3, 11.4.4, AND 11.4.5) IN THEIR ENTIRETY.**

**78. DELETE PARAGRAPH (11.4.6) AND SUBSTITUTE:**

“The Contractor shall file two certified copies of all policies with the Owner before exposure to loss can occur. If the Owner is damaged by the failure of the Contractor to maintain such insurance and to so notify the Owner, then the Contractor shall bear all reasonable costs properly attributable thereto.

**79. DELETE PARAGRAPHS (11.4.7, 11.4.8, 11.4.9, AND 11.4.10) IN THEIR ENTIRETY.**

**80. DELETE PARAGRAPH (11.5.1) AND SUBSTITUTE:**

“The Contractor shall furnish a Performance Bond and a separate Labor and Material Payment Bond, each for one hundred percent (100%) of the Contract Sum. Form of these bonds shall be as provided by the Owner in the Project Manual and no other form will be accepted. The Surety shall be authorized to do business in the State of Illinois and be acceptable to the Owner.

**81. IN PARAGRAPH (12.1.1) DELETE THE WORD “Architect’s” AND SUBSTITUTE WORDS “Owner’s Representative’s and Architect’s”. DELETE THE WORD “Architect” AND SUBSTITUTE THE WORDS “Owner’s Representative”.**

**82. IN PARAGRAPH (12.1.2) AFTER THE WORD “Architect” ADD THE WORDS “and Owner’s Representative”.**

**83. IN PARAGRAPH (12.2.1.1) AFTER THE WORD “Architect” ADD THE WORDS “and Owner’s Representative”.**

**84. IN PARAGRAPH (13.5.4) AFTER THE WORD “Architect” ADD THE WORDS “and Owner’s Representative”.**

**85. IN PARAGRAPH (14.1.1.3) DELETE THE WORD “Architect” AND SUBSTITUTE THE WORDS “Owner’s Representative”.**

**86. IN PARAGRAPH (14.2.2) DELETE THE PHRASE “, upon certification by the Architect that sufficient cause exists to justify such action,”.**

**87. IN PARAGRAPH (14.2.4) DELETE THE WORD “Architect” AND SUBSTITUTE THE WORDS “Owner’s Representative”.**

**88. DELETE PARAGRAPH (14.4.3) IN ITS ENTIRETY AND SUBSTITUTE:**

In case of such termination for the Owner's convenience, the Contractor shall be entitled to receive payment for Work executed, and costs incurred by reason of such termination. In no event, however, will such amounts exceed the Contract Sum reduced by the amount of prior payments except for increases pursuant to the claims procedure in the Contract Documents. Subcontracts, subsubcontracts, and purchase orders will contain appropriate provisions for termination for convenience under this Paragraph 14.4.

**89. ADD THE FOLLOWING ARTICLE 15: LABOR, SAFETY AND WAGE STANDARDS TO THE GENERAL CONDITIONS OF THE CONTRACT:**

**ARTICLE 15  
LABOR, WAGE, SAFETY, AND OTHER STANDARDS**

**15.1 LABOR STANDARDS.** All employers shall comply with the Employment of Illinois Workers on Public Works Act [30 ILCS 570/1 to 570/7].

**15.2 WAGE STANDARDS.**

**15.2.1 PREVAILING WAGE ACT:** Wages and benefits to employees shall comply with all Federal and State of Illinois statutes pertaining to public works projects and specifically: Wages of Employees on Public Works [820 ILCS 130/1 - 12].

**15.2.2** Not less than the prevailing rate of wages as determined by the Park District or the Department of Labor shall be paid to all laborers, workers and mechanics performing work under this contract. All contractor's bonds shall include a provision as will guarantee the faithful performance of such prevailing wage clause as provided by this bid specification or contract.

**15.2.3** The terms "general prevailing rate of hourly wages", "general prevailing rate of wages" or "prevailing rate of wages" when used in this Act mean the hourly cash wages plus fringe benefits for training and apprenticeship programs approved by the U.S. Department of Labor, Bureau of Apprenticeship and Training, health and welfare, insurance, vacations and pensions paid generally, in the locality in which the work is being performed, to employees engaged in work of a similar character on public works.

**15.2.4 PREVAILING WAGE ACT/FOIA**  
Contractors and subcontractors shall submit certified payroll on a monthly basis to the Park District in compliance with requirements of 820 ILCS 130/5. These records will be kept by the Park District for three years and may be reviewed by others through the Freedom of Information Act (FOIA). The Park District will exclude employee's address, telephone number, and social security number from public inspection.

**15.3 SAFETY STANDARDS.**

**15.3.1 PROTECTION OF PERSONS AND PROPERTY:** The Contractor and his subcontractors shall, at all times, comply with applicable provisions of Federal, State and Local laws.

**15.3.1.1** The Contractor and his sub-contractors shall have written programs complying with Occupational Safety and Health Administration standards and/or Illinois Department of Labor requirements including, but not limited to the following: hazardous communications, hearing conservation, respirator use, confined space entry, scaffolding, ladders, ventilation, flammable and combustible liquids, and lockout/tagout. The

Contractor shall submit documentation of their programs at the request of the Owner's Representative, or Occupational Safety and Health Administration and/or Illinois Department of Labor officials.

#### **15.4 EQUAL EMPLOYMENT OPPORTUNITY/AFFIRMATIVE ACTION/SEXUAL HARASSMENT**

**15.4.1** During the performance of the contract, the contractor agrees to the following:

**15.4.1.1** That it will not discriminate against any employee or applicant for employment because of race, color, religion, sex, marital status, national origin or ancestry, age, physical or mental handicap unrelated to ability, or an unfavorable discharge from military service; and further that it will examine all job classifications to determine if minority persons or women are under-utilized and will take appropriate affirmative action to rectify any such under-utilization.

**15.4.1.2** That, if it hires additional employees in order to perform his contract or any portion thereof, it will determine the availability (in accordance with the Rules and Regulations of the Illinois Department of Human Rights) of minorities and women in the area(s) from which it may reasonably recruit and it will hire for each job classification for which employees are hired in such a way that minorities and women are not under-utilized.

**15.4.1.3** That, in all solicitations or advertisements for employees placed by it or on its behalf, it will state that all applicants will be afforded equal opportunity without discrimination because of race, color, religion, sex, marital status, national origin or ancestry, age, physical or mental handicap unrelated to ability or an unfavorable discharge from military service.

**15.4.1.4** That it will have a written sexual harassment policy to include at the minimum, the following:

**15.4.1.4.1** a definition of sexual harassment under the law;

**15.4.1.4.2** a description of sexual harassment utilizing examples;

**15.4.1.4.3** a formalized complaint procedure;

**15.4.1.4.4** a statement of victim's rights;

**15.4.1.4.5** directions on how to contact the Illinois Department of Human Rights. Out-of-state companies must provide directions for filing with the enforcement agency within their state. Companies that issue a standard policy for all business locations must prepare an addendum providing directions on how to contact the appropriate enforcement agency; and

**15.4.1.4.6** A recitation that there cannot be any retaliation against employees who elect to file charges.

**15.4.1.4.7** In addition, it is recommended that the employer post a copy of the sexual harassment policy in a prominent and accessible location and distribute it in a manner to assure notice to all employees on an annual basis.

**15.4.1.4.8** The Illinois Human Rights Act specifically provides that all documents may meet, but cannot exceed, the sixth grade literacy level. Therefore, the employers sexual harassment policy must be stated in plain language and in "laymen's terms".

**15.4.1.5** That it will send to each labor organization or representative of workers with which it has or is bound by a collective bargaining or other agreement or understanding, a notice advising such labor organization or representative of the contractor's obligations under the Illinois Human Rights Act and the Department's Rules and Regulations. If any such labor organization or representative fails or refuses to cooperate with the contractor in its efforts to comply with such Act and Rules and Regulations, the contractor will promptly so notify the Department and the contracting agency and will recruit employees from other sources when necessary to fulfill its obligations thereunder.

**15.4.1.6.** That it will submit reports as required by the Department's Rules and Regulations, furnish all relevant information as may from time to time be requested by the Department or the contracting agency, and in all respects comply with the Illinois Human Rights Act and the Department's Rules and Regulations.

**15.4.1.7.** That it will permit access to all relevant books, records, accounts and work sites by personnel of the contracting agency and the Department for purposes of investigation to ascertain compliance with the Illinois Human Rights Act and the Department's Rules and Regulations.

**15.4.1.8.** That it will include verbatim or by reference the provisions of this clause in every subcontract it awards under which any portion of the contract obligations are undertaken or assumed, so that such provisions will be binding upon such subcontractor. In the same manner as with other provisions of this contract, the contractor will be liable for compliance with applicable provisions of this clause by such subcontractors; and further it will promptly notify the contracting agency and the Department in the event any subcontractor fails or refuses to comply therewith. In addition, the contractor will not utilize any subcontractor declared by the Illinois Human Rights Commission to be ineligible for contracts or subcontracts with the State of Illinois or any of its political subdivisions or municipal corporations.

**15.4.2** In the event of the contractor's non-compliance with the provisions of the Illinois Human Rights Act, the contractor may be declared ineligible for future contracts or subcontracts with the State of Illinois or any of its political subdivisions or municipal corporation, and the contract may be cancelled or voided in whole or in part, and such other sanctions or penalties may be imposed or remedies invoked as provided by statute or regulations.

END OF SUPPLEMENTARY GENERAL CONDITIONS

# DIVISION 010000 GENERAL REQUIREMENTS

## SECTION 010000 - GENERAL

### A. SUMMARY OF THE WORK

1. The Work covered under this Contract consists of that work described by the Invitation to Bid, the Instructions/Supplemental Instructions to Bidders, the Bid/Proposal Form, the General/Supplemental Conditions of the Contract, these General Requirements, the Plans, and the Technical Specifications.
2. The Contractor shall be responsible for all items incidental to the scope of the Work intended by the bidding documents as per A.1 above, including but not limited to, expenses incurred by the requirements of various Sections of Division 010000, unless specifically stated otherwise herein.
3. Changes to the Work as required by approved Change Orders shall be at the expense of the Owner, however, requests for additional payments made after the fact will not be considered.

### B. OCCUPANCY BY OWNER.

1. The Owner reserves the right to occupy any portion of the project before it has been entirely completed, with the understanding that such occupancy shall in no way constitute acceptance of the work, in whole or in part, or of any work performed under the Contract, provided that such occupancy does not substantially interfere with completion of the work by the Contractor.

### C. SUBMITTALS

1. Submit proposals for purchase of products or systems included in allowances, in the form specified for Change Orders.
2. Submit invoices or delivery slips to show the actual quantities of materials delivered to the site for use in fulfillment of each allowance.

### D. UNUSED MATERIALS

1. Return unused materials to the manufacturer or supplier for credit to the Owner, after installation has been completed and accepted.
  - a) When requested by the owner's Representative, prepare unused material for storage by Owner where it is not economically practical to return the material for credit. When directed by the Owner's Representative, deliver unused material to the Owner's storage space. Otherwise, disposal of the unused material is the Contractor's responsibility.

## SECTION 012300 – ALTERNATES

### A. Alternates to the Bid are set forth in the Supplementary Instructions to Bidders and are listed in the Bid Form.

1. Accepted Alternates have been incorporated into the Agreement.

### B. Bid Alternate pricing, as set forth in the Supplementary Instructions to Bidders and the Bid Form, shall be good for a minimum of 90 calendar days after the date of the Bid opening, and the Owner reserves the right to accept Alternates up to that time.

## SECTION 012600 - CHANGE ORDERS

### A. OWNER'S REPRESENTATIVE'S FIELD ORDERS

1. From time to time during progress of the Work the Owner's Representative may issue an "Owner's Representative's Field Order" which interprets the Contract Documents or orders minor changes in the Work without change in Contract Sum or Contract Time.
2. Should the Contractor consider that a change in Contract Sum or Contract Time is required he shall submit an itemized proposal to the Owner's Representative **immediately and before proceeding with the Work**. If the proposal is found to be satisfactory and in proper order, the Field Order will be superseded by a Change Order.

### B. PROPOSAL REQUESTS

1. From time to time during the progress of work the Owner's Representative may issue a "Proposal Request" for an itemized quotation for changes to the Work which may result in a change to the Contract Sum or Contract Time. This document is **not a Change Order** and is not a direction to proceed with the changes described therein.

### C. CHANGE ORDERS

1. Change Orders are written documents describing changes in the Work, in the Contract Sum, in the Contract Time of Completion, or any combination thereof. Change Orders must be signed by both the Owner and the Architect/Owner's Representative prior to proceeding with the Work subject to the Change Order. **REQUESTS FOR "EXTRA'S" OR OTHER ADDITIONAL PAYMENTS OVER AND ABOVE THE CURRENT CONTRACT SUM WILL NOT BE CONSIDERED WITHOUT THE PRIOR, WRITTEN APPROVAL OF BOTH THE OWNER AND THE OWNER'S REPRESENTATIVE.**
  - a) INITIATION. Change Orders may be initiated by a "Field Order" or "Proposal Request" per paragraphs "A" and "B" above. In addition, either the Contractor or Owner (or Owner's Representative) may initiate a Change Order through:
    - 1) Discovery of a discrepancy in the Contract Documents,
    - 2) Discovery of concealed conditions or,
    - 3) Discovery, during the course of the Work, of methods of accomplishing the Work in a better or more economical manner.
  - b) PROCESSING CHANGE ORDERS.
    - 1) Change Orders will be dated and will be numbered in sequence.
    - 2) The Change Order will describe the change or changes, or will refer to the Proposal Requests or Field Orders involved.
    - 3) The Owner's Representative will issue three copies of each Change Order to the Contractor.
    - 4) The Contractor promptly shall sign all three copies and return them to the Owner's Representative.
    - 5) The Owner and Owner's Representative will retain two signed copies in their files, and will forward one signed copy to the Contractor.
    - 6) Should the Contractor disagree with the stipulated change in Contract Sum or change in Contract Time of Completion, or both:

- i) The Contractor promptly shall return all three of the Change Orders, unsigned by him, to the Owner's Representative with a letter signed by the Contractor stating the reason or reasons for the Contractor's disagreement.
- ii) The Contractor's disagreement with the Change Order shall not in any way relieve the Contractor of his responsibility to proceed with the change as ordered and to seek settlement of the dispute under pertinent provisions of the Contract Documents.

**SECTION 012900 – PAYMENT PROCEDURES**

**A. SCHEDULE OF VALUES**

- 1. Prior to the start of construction, submit a proposed Schedule of Values to the Owner's Representative which shows a detailed breakdown of the agreed Contract Sum showing values allocated to each of the various parts of the Work, as specified herein and in other provisions of the Contract Documents.
  - a) The Schedule of Values is required to be compatible (in the same format) with the Application for Payment "Continuation Sheet", AIA G703.
- 2. If not requested to submit additional data or to modify the submitted Schedule of Values within ten (10) days of submittal, the initially submitted Schedule shall be deemed approved.

**B. APPLICATIONS FOR PAYMENT**

- 1. Progress payments will be made only if specifically called for in the Agreement. In all other cases, the Contractor may submit an Application for Payment (3 copies) upon Substantial Completion (95% of the Contract Sum), with the balance of the Contract Sum to be paid at Final Completion.
  - a) **Paragraph #52 of the Supplementary General Conditions defines the documentation required for each payment request.**
  - b) Applications for payment shall be delivered to the Owner's Project Manager at:

Department of Planning, Design, and Construction  
 Peoria Park District  
 Bradley Park Equipment Service  
 1314 N. Park Road  
 Peoria, Illinois 61604

**SECTION 013100 - PROJECT MEETINGS**

**A. PRECONSTRUCTION CONFERENCE**

- 1. Conduct a preconstruction conference prior to the start of the Work, at the location of the Work. Provide attendance by the designated personnel of the Contractor, including Sub-contractor's and/or suppliers of major components of the Work, if requested by the Owner's Representative.
  - a) **AGENDA.** Discuss items of significance that could affect progress including such topics as:
    - 1) Tentative construction schedule.
    - 2) Critical Work sequencing.
    - 3) Designation of responsible personnel.
    - 4) Procedures for processing field decisions and Change Orders.
    - 5) Procedures for processing Applications for Payment.
    - 6) Distribution of Contract Documents.
    - 7) Submittal of Shop Drawings, Product Data and Samples.
    - 8) Preparation of record documents.
    - 9) Use of the premises.
    - 10) Office, Work and storage areas.
    - 11) Equipment deliveries and priorities.
    - 12) Safety procedures.
    - 13) First aid.
    - 14) Security.
    - 15) Housekeeping.
    - 16) Working hours.
    - 17) Permits and Permitting Agency Requirements

**B. PROJECT MEETINGS**

- 1. Project Meetings will be held per the schedule determined at the Preconstruction Conference, or as needed for proper coordination and administration of the project.
  - a) **AGENDA**
    - 1) Review and correct or approve minutes of the previous progress meeting.
    - 2) Review progress of the Work since last meeting, including status of submittals for approval.
    - 3) Identify problems which impede planned progress.
    - 4) Develop corrective measures and procedures to regain planned schedule.
    - 5) Complete other current business.

**C. REPORTING**

- 1. Distribute copies of the minutes of each meeting to each party present, and to other parties who should have been present, no later than three business days after each meeting.

**SECTION 013300 - SUBMITTALS**

- A. Requirements for shop drawings, samples, mock-ups, product data, etc., relative to specific elements or components of the work are called out in the various sections of the Technical Specifications.

1. Submit items to allow for Owner's Representative's review and approval, potential re-submission if full approval is not given, ordering, delivery, fabrication time, etc., so as to allow the Work to proceed in a timely manner and in conformance with the project schedule.
- B. OTHER CONTRACTOR SUBMITTALS
1. Unless otherwise modified the Contractor shall also submit:
    - a) A "bar chart" type proposed construction schedule, within ten days after award of the Bid.
    - b) Other submittals as required by other section of Division 010000.
- C. Submission of the required Bonds and Certificate of Insurance are to be made prior to the Owner's issuance of a Notice to Proceed.

#### SECTION 014000 – QUALITY/REGULATORY REQUIREMENTS

- A. GENERAL: Contractors shall comply with all laws, rules and regulations governing the work.
1. When Contractor observes that contract documents are at variance with specified codes, notify Owner's Representative in writing immediately. Owner's Representative will issue all changes in accord with General Conditions.
  2. When Contractor performs any work knowing or having reason to know that the work is contrary to such laws, rules and regulations and fails to so notify the Owner's Representative, Contractor shall pay all costs arising therefrom. However, it will not be the Contractor's primary responsibility to make certain that the contract documents are in accord with such laws, rules and regulations.
- B. SAFETY:
1. Comply with all federal, state, and local laws, rules and regulations governing the installation/construction of the work.
  2. Develop and utilize safety program and training for workmen and sub-contractor employees.
- C. TESTING
1. TESTS AND INSPECTIONS REQUIRED
    - a) Provide all tests and inspections required by governmental agencies having jurisdiction, as required by provisions of the Contract Documents and/or as specifically required by sections of the Technical Specifications.
  2. PAYMENT FOR TESTING
    - a) Include within the Contract Sum an amount sufficient to cover all testing, re-testing, and inspections required by the Contract documents and/or the Technical Specifications. Additionally pay for all testing and inspections required by all governmental agencies having jurisdiction.
      - 1) The Owner will pay for any testing and inspecting specifically requested by the Owner's Representative which are over and above those described in Paragraph 1.a) above.
      - 2) When initial tests (over and above those defined by 1.a) above) requested by the Owner's Representative indicate non-compliance with the Contract Documents, costs of initial tests associated with that non-compliance will be deducted by the Owner from the Contract Sum, and subsequent retesting occasioned by the non-compliance shall be performed by the same testing laboratory and the costs thereof shall be paid by the Contractor.
  3. WAIVER OF INSPECTION AND/OR TESTS
    - a) Specified inspections and/or tests may be waived only by the specific written approval of the Owner's Representative, and **such waivers will be expected to result in credit to the Owner equal to normal cost of such inspection and/or test.**

#### SECTION 014200 - REFERENCE STANDARDS AND DEFINITIONS

- A. Copies of Standards: Each entity engaged in construction on the Project is required to be familiar with industry standards applicable to that entity's construction activity. Copies of applicable standards are not bound with the Contract Documents.
1. Where copies of standards are needed for performance of a required construction activity the Contractor shall obtain copies directly from the publication source.
  2. Although copies of standards needed for enforcement of requirements may be included as part of required submittals the Architect reserves the right to require the Contractor to submit additional copies as necessary for enforcement of requirements.
- B. Abbreviations and Names: Trade association names and titles of general standards are frequently abbreviated. Where such acronyms or abbreviations are used in the Specifications or other Contract Documents they mean the recognized name of the trade association standards generating organization authority having jurisdiction or other entity applicable to the context of the text provision. Refer to the Encyclopedia of Associations, published by Gale Research Co. available in most libraries.
- C. Definitions: Architect, Owner's Representative, and Owner's Project Manager
1. **ARCHITECT:** The Architect shall be the person or entity designated by the Owner as the Owner's Representative and shall be identified as such in the Agreement Between Owner and Contractor, and is referred to throughout the Contract Documents as if singular in number and masculine in gender.
  2. **OWNER'S REPRESENTATIVE:** The duties of the Owner's Representative as listed in the Project Manual, include but are not limited to, construction phase observation and technical administration services.
    - a) **LIMITS OF AUTHORITY:** The Owner's Representative shall be authorized to provide approvals and interpretations concerning the plans, specifications and progress of the Work as bid, but is not authorized to change the scope of the Work on behalf of the Owner.
  3. **OWNER'S PROJECT MANAGER:** The Owner's Project Manager will represent, act on behalf of, and provide interface between the Owner and the Contractor in respect to contract administration and/or other matters which affect the scope of the Work.
    - a) Unless defined otherwise in the Project Manual, the Owner's Project Manager shall be a designated member of the Planning, Design, and Construction Division of the Peoria Park District.
    - b) The Owner's Project Manager will also be the Owner's Representative and will provide construction phase observation and technical administration services, if a consultant Architect has not been engaged to do so, by the Owner.

#### SECTION 015000 – TEMPORARY FACILITIES & CONTROLS

- A. MOBILIZATION
1. Furnish all labor, tools, materials, equipment, and incidentals necessary for preparatory work.
  2. Provide and establish personnel, equipment, supplies, materials, offices or buildings, and other facilities necessary to work on the project.
  3. Demobilize all of the above and remove temporary facilities at the completion of the project.
- B. BARRIERS, PROTECTION OF SITE AND PROPERTY
1. GENERAL
    - a) Owner's improvements to remain, existing utilities, as well as adjacent site improvements shall be protected from damage by barriers, guards and coverings. Damaged work shall be replaced or repaired to condition prevailing at time of signing of contract, at no additional cost to Owner.
    - b) Provide 6' high, continuous chain link or orange plastic (used materials acceptable) construction fence to prohibit unauthorized personnel or public entry from the site of the Work. (Substitutions may be considered; submit request in writing to the Owner's Representative.)
    - c) Contractor shall provide, erect and maintain additional planking, fences, protective canopies, railings, shoring, lights, warning signs, etc., as needed for the protection of adjacent property and the public.
  2. LANDSCAPE PROTECTION
    - a) All live, healthy trees, shrubs, etc. on the site or on the street fronts of the site, not specified to be removed and not interfering with installation of new work required hereunder, shall be protected against injury from construction operations.
    - b) All shade trees which are to remain and which are liable to damage during the building operations, shall be properly boxed and protected from damage during the course of construction work as directed by the Park District. **No site-related work shall occur until the required tree protection (fencing, boxing, etc.) has been installed and approved by the Owner or his representative.**
      - 1) LIQUIDATED DAMAGES: The Owner reserves the right to charge the Contractor for damage to existing trees, and to deduct the charges from the amounts due the Contractor, based on the following schedule:
 

aa) Broken limbs 1" or over in diameter:	\$50 per caliper inch of limb
bb) Trenching or grading within the tree dripline or 20' from the trunk, whichever is less, of trees 4" or over in caliper diameter:	\$100 per tree/per foot within dripline, or within 20' minimum if applicable
cc) Damage to tree trunks, including "barking", nicking, gouging, etc.	\$150 per caliper inch of tree, per each injury
  3. BARRIERS/CONSTRUCTION FENCE MATERIALS
    - a) 2" open mesh chain link fence, 72" high minimum, galvanized, with appropriately sized posts; gates where indicated.
    - b) Alternate barrier fencing materials may be acceptable, however, no additional payments will be made on account of approval of alternate barrier/safety fencing materials.
    - c) Materials may be new or used, if in serviceable condition.
  4. WATCHMAN SERVICE
    - a) The Owner will not be responsible for loss due to theft or other damage which is not covered under Property Insurance. The Contractor shall make such arrangements for watchman service as he considers necessary and he shall be responsible for all loss or damage of his property, equipment, material, etc., at the site, and he shall make good such damage or loss without any additional cost to the Owner.
  5. EXISTING IMPROVEMENTS - PROTECTION
    - a) The Contractor shall be entirely responsible for all injuries to water pipes, electric conduits or cables, drains, sewers, gas mains, poles, telephones and telegraph lines, streets, pavements, sidewalks, curbs, culverts, retaining walls, building walls, foundation walls, or other structures of any kind met with during the progress of the Work, and shall be liable for damages to public or private property resulting therefrom.
- C. CONSTRUCTION ACCESS, ROADS, AND PARKING AREAS
1. CONTRACTOR'S USE OF PREMISES
    - a) The Contractor shall require that all personnel who will enter upon the Owner's property certify their awareness of and familiarity with the requirements of this Section.
  2. CONSTRUCTION ACCESS
    - a) To avoid traffic conflict with vehicles of the Owner's employees and customers, and to avoid over-loading of streets and driveways elsewhere on the Owner's property, limit the access of trucks and equipment to the route shown (IF SHOWN) on the Drawings as "Access Route". If access route is not shown on the Drawings, coordinate construction access and routes with the Owner's Project Manager.
    - b) Do not permit such vehicles to park on any street or other area of the Owner's property except in the area shown on the Drawings as "Contractor's Parking Area". If not shown on the drawings, the Contractor's Parking Area shall be as designated by the Owner's Project Manager.
    - c) Provide adequate protection for curbs and sidewalks over which trucks and equipment pass to reach the job site.
  3. SECURITY
    - a) Restrict the access of all persons entering upon the Owner's property in connection with the Work to the Access Route and to the actual site of the Work.
- D. TEMPORARY ENVIRONMENTAL CONTROLS
1. GENERAL
    - a) Provide temporary environmental controls at the site of the Work to ensure that construction operations have no harmful effects on adjacent properties and on members of the public who may come in proximity to the Work, and/or the employees of the Owner who are engaged in regular daily tasks and operations and are unable to be relocated to another work site during construction operations.
    - b) Owner reserves the right to stop the Work, at the Contractor's expense, until the Contractor provides necessary control measures for the conditions listed below; additionally, the Owner reserves the right to perform or have performed necessary control measures, should the Contractor refuse to do so at the time requested and to deduct the cost of those expenses from the amount due the Contractor.
  2. DUST CONTROL
    - a) Provide dust control materials to minimize dust from construction operations. Prevent air-borne dust from dispersing into the atmosphere.
  3. WATER CONTROL
    - a) Control surface water to prevent damage to the project, the site and adjoining properties.



- 1) Control fill, grading, and ditching to direct surface drainage away from excavations, pits, tunnels, and other construction areas; direct drainage to proper runoff channels or storm drainage utilities.
  - b) Provide, operate and maintain hydraulic equipment of adequate capacity to control surface water.
  - c) Dispose of drainage water in a manner to prevent flooding, erosion silting, or runoff of silt or sediment or other damage to all portions of the site or to adjoining properties.
4. RODENT CONTROL
    - a) Provide rodent control to prevent infestation of construction or storage areas.
      - 1) Use methods and materials which will not adversely affect conditions at the site or on adjoining properties.
  5. DEBRIS CONTROL
    - a) Maintain all areas free of extraneous debris, waste, and rubbish.
  6. POLLUTION CONTROL
    - a) Prevent contamination of soil, water or atmosphere by the discharge of noxious substances from construction operations.
    - b) Provide equipment and personnel, perform emergency measures to contain all spillages, and to remove contaminated soils or liquids.
      - 1) Excavate and dispose of all contaminated earth off-site. Replace with suitable compacted fill and topsoil.
    - c) Take special measures, as necessary, to prevent harmful substances from entering public waters, including lakes, streams, intermittent drainage channels, and storm or sanitary sewers.
  7. EROSION CONTROL
    - a) Plan and execute construction and earthwork in a manner to control surface drainage from cuts and fills, and from borrow and waste disposal areas, to prevent erosion and sedimentation.
      - 1) Schedule the Work to minimize the areas of bare soil exposed at one time, if possible.
      - 2) Provide temporary control measures such as berms, dikes, and drains to prevent runoff of silt or sediment from the site.
      - 3) Comply with Section 015713.
- E. PROJECT IDENTIFICATION AND SIGNAGE
1. GENERAL
    - a) Provide and install project identification sign, if located and/or called out on the Drawings.
  2. SUBMITTALS
    - a) Provide shop drawing(s) of proposed sign/sign installation to Owner's Representative for approval, prior to installation
  3. INSTALLATION
    - a) Provide project sign as detailed on Drawings
    - b) If not detailed on Drawings provide project identification sign per the following minimum requirement:
      - 1) Content
        - aa) Name of project
        - bb) Name of Owner
        - cc) Name of Architect(s) and major consultants
        - dd) Names of Contractor and major subcontractors
        - ee) Allow additional 200 characters of text explaining the project
      - 2) Construction
        - aa) Size: 4' x 8'
        - bb) Materials: Min. 5/8" AC DFPA Exterior Plywood, with (2) 4" x 4" x 12' long pressure treated post supports
        - cc) Paint: paint front and back, seal edges, provide content as approved by Owner's Representative. Conform to recognized sign painting standards in selection of paint materials. Use only professional sign painter with three years minimum experience to apply sign graphics and lettering.
      - 3) Install sign in a manner consistent with length of time of construction operations. Remove sign and fill post holes at project completion.
- F. FIELD OFFICES
1. TEMPORARY FACILITIES
 

Provide and pay for temporary (new, or used if in serviceable condition) facilities and controls needed for the Work, if called out on the Drawings, which may include, but are not necessarily limited to:

    - a) Temporary utilities such as heat, water, electricity, and telephone;
    - b) Field office for the Contractor's personnel (required if shown on the Drawings; otherwise at the Contractor's option and expense).
      - 1) Conform with requirements for Engineer's Field Office Type B, as defined in Article 646.04 of the Standard Specifications for Road and Bridge Construction - Illinois Department of Transportation.
    - c) Sanitary facilities;
    - d) Enclosures such as tarpaulins, barricades, and canopies;
    - e) Temporary fencing of the construction site;
    - f) Project sign.
  2. Comply with Federal, State, and local codes and regulations.
    - a) Maintain temporary facilities and controls in proper and safe condition throughout the progress of the work. The Contractor is responsible for conformance with all safety codes and regulations for all Work under his jurisdiction, including that of Sub-Contractors.
  3. Locate temporary facilities as shown on the Drawings, or as approved by the Owner's Representative if not shown on the Drawings.

## SECTION 015713 – EROSION & SEDIMENT CONTROL

### A. RELATED DOCUMENTS

1. Drawings and general provisions of the Contract, including General and Supplementary Conditions and Division 1 Specification Sections, apply to this Section.

### B. SUMMARY

1. This Section includes the following:
  - a) Site erosion and sediment control
  - b) Silt fencing
  - c) Ditch checks
  - d) Erosion control blankets
  - e) Culvert and inlet protection
  - f) Stabilized entrance
2. Related Sections include the following:
  - a) Division 31 – Earthwork.
  - b) Division 32 – Exterior Improvements.
3. Erosion and Sediment Control Statement: The Peoria Park District takes the issue of construction related erosion and sediment control extremely seriously. The Peoria Park District is a community leader in the conservation and protection of our area’s natural resources. This project will be watched closely by both staff and citizens for compliance with erosion and sediment control regulations and specifications.

C. QUALITY ASSURANCE

1. Materials and methods of construction shall comply with the following standards:
  - a) Illinois Department of Transportation
  - b) City of Peoria

D. PRODUCTS

1. Silt Fencing
  - a) Fabric for silt fencing shall consist of woven or nonwoven filaments of polypropylene, polyester, or polyethylene. Fabric shall be resistant to degradation by ultraviolet light and heat exposure. Fabric shall be rot, insect, and mildew proof, and have a high resistance to tearing.
    - 1) Fabric shall comply with the following physical properties:
 

aa) Grab tensile strength (lb) – ASTM D4632	200 (min)
bb) Grab elongation @ break (%) – ASTM D4632	12
cc) Burst strength (psi) – ASTM D751	250 (min)
dd) Trapezoidal tear strength (lb) – ASTM D4533	75
ee) Width (ft)	3.5 (min)
ff) Weight (oz/sq. yd) – ASTM D3776	4.0
gg) Equivalent opening size	30 (nonwoven)
hh) (EOS) sieve no. – Corps of Engrs. CS-02215	50 (woven)
2. Ditch Checks
  - a) Ditch checks will consist of silt fencing with the addition of wire reinforcement.
  - b) Wire shall be 9 gauge.
  - c) Alternate: Straw bales may be used in lieu of silt fencing
3. Posts
  - a) Posts shall be standard “T” or “U” steel posts or wood with a minimum cross section of 3 square inches. Posts shall be a minimum of 60” in length. Posts shall be driven a minimum of 24” into the ground.
4. Erosion Control Blankets
  - a) Excelsior Blanket: Excelsior blanket shall consist of a machine produced mat of wood excelsior of 80% 6” or longer fiber length. The wood from which the excelsior blanket is cut shall be properly cured to achieve adequately curled and barbed fibers.
    - 1) The blanket shall be of consistent thickness, with the fiber evenly distributed over the entire area of the blanket. The excelsior blanket shall be covered on the top side with a 90 day biodegradable extruded plastic mesh netting having an approximate minimum opening of 16 x 16 mm (5/8 x 5/8 in.) to an approximate maximum opening of 50 x 25 mm (2 x 1 in.). The netting shall be substantially adhered to the excelsior blanket by a knitting process using biodegradable thread or by an applied degradable adhesive. The netting shall be substantially adhered to the excelsior by a knitting process using biodegradable thread. The netting shall be entwined with the excelsior blanket for maximum strength and ease of handling.
    - 2) The excelsior blanket shall comply with the following:
 

aa) Minimum width, ± 25 mm (1 in.)	600 mm (24 in.)
bb) Minimum mass ± 10%	0.34 kg/sm (0.63 lb/sq yd)
cc) Minimum length of roll, approximately	45 m (150 ft)
    - 3) The excelsior blanket shall be smolder resistant.
5. Culvert And Inlet Protection
  - a) Culvert protection shall consist of a ditch check immediately upstream of every culvert entrance. Ditch check shall be installed to protect culvert interior from sedimentation.
  - b) Inlet protection shall consist of purpose made devices by:
 

Dandy Products, Inc.  
P. O. Box 1980  
Westerville, Ohio 43086-1980  
Phone: 1-800-591-2284  
Fax: 740-881-2791  
[www.dandyproducts.com](http://www.dandyproducts.com)  
[dlc@dandyproducts.com](mailto:dlc@dandyproducts.com)

or

NILEX, Inc.  
15171 E. Fremont Drive  
Centennial, CO 80112  
Phone: 1-800-537-4241  
Fax: 303-766-1110  
[www.nilex.com](http://www.nilex.com)

[denver@nilex.com](mailto:denver@nilex.com)

c) "Or Equal" substitutions may be made with prior approval of Owner's Representative.

6. Stabilized Entrance

- a) Stabilized entrance shall consist of coarse aggregate laid over geotextile fabric.
- b) Dimensions: 70' long by 14' wide.
- c) Geotextile Fabric: as per requirements of "silt fencing".
- d) Aggregate: IDOT Class CA-1, CA-2, cA-3, or CA-4.

E. EXECUTION

1. Site Erosion And Sediment Control

- a) Contractor is responsible for fulfilling terms of City of Peoria Erosion Control Permit and all applicable portions of the "Erosion, Sediment, and Stormwater Control Ordinance of the City of Peoria".
- b) Install control devices as shown on erosion control plan.
- c) Install additional measures as needed to control erosion and sedimentation on the site.

2. Silt Fencing Installation

- a) Install silt fencing according to details in plans. The silt fence shall be entrenched to a minimum depth of 8".
- b) The silt fence shall be installed on the contour, with the ends extending up-slope.
- c) Install silt fencing before commencing site clearing work.

3. Ditch Check Installation

- a) Install ditch checks according to details in plans.
- b) Install ditch checks at locations shown on plans.
- c) Install additional ditch checks as needed to control erosion within drainage swales as site conditions and weather dictate.
- d) Install ditch checks immediately after swales are graded.

4. Erosion Control Blankets Installation

- a) Install erosion control blankets as needed to control erosion in drainage swales and at the direction of the Owner's Representative.
- b) Anchor stakes shall be driven at a spacing of 2 feet on center.

5. Culvert And Inlet Protection Installation

- a) Install culvert protection at upstream entrances to all culverts.
- b) Install culvert protection to intercept waterborne silt and sediment and prevent it from entering culvert pipes.
- c) Install immediately after culvert installation.
- d) Install inlet protection according to manufacturer's written instructions at each inlet immediately after inlet construction.

6. Stabilized Construction Entrance Installation

- a) Install stabilized construction entrance and other approved measures as necessary to limit tracking of soil on to all paved surfaces.
- b) Comply with all City of Peoria codes limiting tracking of soil on to City streets.

7. Maintenance

- a) Inspect silt fences after each rainfall. Repair fencing, failures, end runs, and erosion cuts immediately.
- b) Remove soil from silt fencing after each rainfall.
- c) Erosion control maintenance and repair shall be considered incidental to the contract.
- d) Tracked soil and sediment shall be removed from all paved surfaces on a daily basis.
- e) Replace or provide new erosion and sediment control measures as needed during construction to provide protection to site and surrounding property for the entire time of construction, or until project is complete.

8. Close-Out

- a) Remove silt fencing and other erosion and sediment control devices after lawn or seeding has been established.
- b) Soil deposits remaining in place after silt fence is no longer required shall be dressed to conform to existing grade, and seeded with appropriate seed material.

**SECTION 016000 – PRODUCT REQUIREMENTS**

A. MATERIALS AND EQUIPMENT

1. STANDARD SPECIFICATIONS

- a) Reference herein to known standard specifications of governmental agencies or technical societies shall refer to the latest edition of such specifications, adopted and published at date of these Specifications.

2. MANUFACTURED ARTICLES

- a) All manufactured articles, materials and equipment to be incorporated in the work shall be new (unless otherwise specified) and of the quality specified and shall be used, erected, installed, connected, cleaned and conditioned as directed by and in conformity with job conditions to produce the best results obtainable.
  - 1) Field measurements for all special products and materials which requires close tolerances or fitting into other items or components of the Work shall be taken on the job by the party furnishing the materials.

3. QUALITY ASSURANCE

- a) Per the Supplementary Instructions to Bidders, the Bidder by submission of a signed bid form, agrees to install products and equipment by brand and model name or names specified in the Technical Specifications, Divisions 02-35. Substitutions are allowed only in conformance to the following:
  - 1) Proprietary Specification Requirement: Where only a single product or manufacturer is named, provide the product indicated. No substitutions will be permitted.
  - 2) Semiproprietary Specification Requirement: Where two or more products or manufacturers are named, provide one of the products indicated. No substitutions will be permitted
    - aa) Where either of the two cases above prevail, and the named product is accompanied by "or approved equal" substitutions will be allowed only upon written approval of the Owner's Representative prior to submission of bids.
  - 3) Non-Proprietary Specification Requirement: When the Specifications lists products or manufacturers that are available and are accompanied by "or equal", the Contractor may propose any available product that complies with the Specifications' requirements; however, the Owner's Representative shall determine if the produced item complies with those requirements.

- 4) Descriptive Specification Requirement: Where Specifications describe a product or assembly listing exact characteristics required, with or without use of a brand, trade, or model name, provide a product or assembly that provides the characteristics and otherwise complies with the Contract Documents.
  - 5) Performance Specification Requirement: Where Specifications require compliance with performance requirements, provide products or assembly that comply with these requirements and are recommended by the manufacturer for the application indicated.
  - 6) Compliance with Standards, Codes, and Regulations: Where the Specifications only require compliance with an imposed code, standard, or regulation, select a product that complies with the standard, code, or regulation specified.
- b) **VISUAL MATCHING AND SELECTION**. Where the Specifications require matching an established sample or call for "as selected", the Owner's Representative's decision will be final on whether a proposed product matches satisfactorily.

**B. STORAGE AND PROTECTION**

1. **GENERAL**

- a) Contractor shall provide and maintain:
  - 1) Storage for materials and equipment to be installed in Project.
  - 2) Protection and security for stored materials and equipment, on and off site.
  - 3) Protection of existing on-site elements to remain.
  - 4) Protection of adjacent properties improvements

2. **METHODS**

- a) Store off grade and cover with impervious material all moisture or water vulnerable materials.
- b) Store finished products and equipment in an enclosed building, on or off site.
- c) Maintain integrity of shipping cartons until ready for installation.
- d) Provide separate storage for combustible and non-combustible products.
- e) Follow storage recommendations of product and equipment manufacturers.
- f) Other methods shall be subject to Owner's prior written approval.

3. The Contractor shall maintain an emergency phone number where a contact person can be notified at any time, Sundays and holidays included, of an emergency condition due to the work which requires immediate repair or protection.

**C. SUBSTITUTIONS**

1. See "SECTION 016000 – A. MATERIALS AND EQUIPMENT" for requirements pertaining to substitution of specified materials, products, equipment, etc.
2. Contractor may propose substitute materials, products, equipment, etc., after award of the Bid; however, such proposals are expected to result in a cost savings to the Owner and/or higher quality Work at no additional cost to the Owner.

**D. WARRANTIES AND BONDS**

1. **GENERAL**

- a) This Section specifies general administrative and procedural requirements for warranties and bonds required by the Contract Documents, including manufacturer's standard warranties on products and special warranties.
- b) Warranties for the Work and products and installations of each Contractor shall be one (1) year unless specified otherwise in the individual Sections of Divisions 02 through 35.
- c) **Disclaimers and Limitations:**
  - 1) Manufacturer's disclaimers and limitations on product warranties do not relieve the Contractor of the warranty on the Work that incorporates the products, nor does it relieve suppliers, manufacturers, and Contractors required to countersign special warranties with the Contractor.
  - 2) The responsibility of the Contractor in respect to the required warranties shall not be relieved or limited in any way by the failure of installed components, equipment, materials, etc., due to naturally occurring and/or re-occurring conditions at the site or area of the Work including, but not limited to:
    - aa) ground and soil conditions, especially as related to frost heave;
    - bb) high wind velocities (except those exceeding velocities normally used for calculating wind loading at the site of the Work);
    - cc) rain and water damage (unless caused by winds exceeding normal design limits);
    - dd) ice/snow loading on structures
    - ee) and other naturally occurring or re-occurring site conditions
  - 3) The Contractor shall notify the Owner's Representative, prior to the award of the contract, of any part or component of the Work that is, in his opinion, not designed to accommodate the existing, naturally occurring, or re-occurring conditions of the site, and whether or not a change in the proposed methods of construction, types of equipment, etc., will affect the bid price.
    - aa) Should the proposed change in construction methods, equipment type, etc., result in additional expense, the Owner reserves the right to request proposals from the other bidders and to make award the contract based on the bid amount which includes the proposed change.

2. **WARRANTY REQUIREMENTS**

- a) **Related Damages and Losses**: When correcting warranted Work that has failed, remove and replace other Work that has been damaged as a result of such failure or that must be removed and replaced to provide access for correction of warranted Work.
- b) **Reinstatement of Warranty**: When Work covered by a warranty has failed and been corrected by replacement or rebuilding, reinstate the warranty by written endorsement. The reinstated warranty shall be equal to the original warranty with an equitable adjustment for depreciation.
- c) **Replacement cost**: Upon determination that Work covered by a warranty has failed, replace or rebuild the Work to an acceptable condition complying with requirements of the Contract Documents. The Contractor is responsible for the cost of replacing or rebuilding defective Work regardless of whether the Owner has benefited from use of the Work through a portion of its anticipated useful service life.

- d) Owner's Recourse: Written warranties made to the Owner are in addition to implied warranties, and shall not limit the duties, obligations, rights and remedies otherwise available under the law, nor shall warranty periods be interpreted as limitations on time in which the Owner can enforce such other duties, obligations, rights or remedies.
    - aa) Rejection of Warranties: The Owner reserves the rights to reject warranties and to limit selections to products with warranties not in conflict with requirements of the Contract Documents.
  - e) The Owner reserves the right to refuse to accept Work for the Project where a special warranty, certification, or similar commitment is required on such Work or part of the Work, until evidence is presented that entities required to countersign such commitments are willing to do so.
  - f) For specific warranty requirements related to landscape materials, refer to the applicable Section.
3. SUBMITTALS
- a) Submit written warranties to the Owner's Representative prior to the date certified for Substantial Completion. If the Owner's Representative's Certificate of Substantial Completion designates a commencement date for warranties other than the date of Substantial Completion for the Work, or a designated portion of the Work, submit written warranties upon request of the Owner's Representative.
    - 1) When a designated portion of the Work is completed and occupied or used by the Owner, by separate agreement with the Contractor during the construction period, submit properly executed warranties to the Owner's Representative within fifteen days of completion of that designated portion of the Work.
  - b) Form of Submittal: At Final Completion, compile two copies of each required warranty and bond properly executed by the Contractor, or by the Contractor, Subcontractor, supplier, or manufacturer. Organize the warranty documents into an orderly sequence based on the table of contents of the Project Manual.
  - c) Bind warranties and bonds in heavy-duty, commercial quality, durable 3-ring vinyl covered loose-leaf binders, thickness as necessary to accommodate contents, and sized to receive 8-1/2" by 11" paper.
  - d) Provide heavy paper dividers with celluloid covered tabs for each separate warranty. Mark the tab to identify the product or installation. Provide a typed description of the product or installation, including the name of the product, and the name, address and telephone number of the installer.
  - e) Identify each binder on the front and the spine with the typed or printed title "WARRANTIES AND BONDS", the project title or name, and the name of the Contractor.
  - f) When operating and maintenance manuals are required for warranted construction, provide additional copies of each required warranty, as necessary, for inclusion in each required manual.

## SECTION 017300 – EXECUTION

### A. GEOTECHNICAL DATA

1. If the Owner has caused borings or other subsurface investigations to be made, the data or report pursuant to these investigations will be included in the Project Manual, as an Appendix, and labeled as such.
2. The Owner and Owner's Representative do not guarantee the accuracy or validity of the data, nor do they assume any responsibility for the Contractor's interpretation of the data.
3. The Contractor's may, at his option, perform additional subsurface investigation, however, it shall be at the Contractor's sole expense.

### B. FIELD ENGINEERING

Provide such field engineering services as are required for proper completion of the Work including, but not limited to:

1. Establishing and maintaining lines and levels
2. Structural design of shores, forms, and similar items provided by the Contractor as part of his means and methods of construction.
3. Verify layout information shown on the Drawings, in relation to the property survey and existing benchmarks and control points. Preserve permanent reference points during construction.

### C. COORDINATION OF TRADES AND SUB-CONTRACTORS

1. The Contractor shall be responsible for the proper fitting of all work and for the coordination of the operation of all trades, sub-contractors, or materials and men engaged upon the work. He shall be prepared to guarantee to each of his subcontractors the dimensions which may be required for fitting of their work to all surrounding work and shall do, or cause his agents to do, all cutting, fitting, adjusting and patching necessary to make the several parts of the work come together properly and fit the work to receive, or be received by that of other contractors.
2. When two or more prime contracts are being executed at one time in such manner that the work on one contract may interfere with the work of another, the Owner's Representative shall decide which contractor shall cease work and which shall continue, or whether the work on both contracts may progress at the same time and in what manner.
  - a) The Contractor shall not cause any unnecessary hindrance or delay to any other contractors on the premises, and shall be responsible for all damages done to the work of other contractors caused by him or by his employees.

### D. REFERENCE AND CONTROL POINTS PROVIDED BY OWNER

In addition to layout procedures provided by the Contractor for proper performance of the Contractor's responsibilities:

1. Locate and protect existing control points before starting work on the site.
2. Preserve permanent reference points during progress of the Work.
3. Do not change or relocate reference points or items of the Work without specific approval from the Owner's Representative.
4. Promptly advise the Owner's Representative when a reference point is lost or destroyed, or requires relocation because of other changes in the Work.
5. Upon direction of the Owner's Representative, require the field engineer to replace reference stakes or markers.
6. Locate such replacement according to the original survey control.

### E. REFERENCE AND CONTROL POINTS PROVIDED BY THE CONTRACTOR

1. If not provided by the Owner (and defined as the responsibility of the Owner in the Contract Documents) establish sufficient general reference points in the form of permanent bench marks, grade stakes or other markers as will enable the Contractor to proceed with the Work.
2. The Contractor may lay out his own work, or cause the Work to be laid out by a qualified party such as a Registered Land Surveyor or a Professional Engineer, as necessary.
3. The Contractor shall establish and be responsible for all lines, elevations and measurements of the structure utilities, installations, and other Work executed by him under the contract.

- a) Exercise proper precautions to verify the figures and dimensions shown on the drawings before laying out the work; be responsible for any error resulting from failure to exercise such precaution.

#### **SECTION 017329 - CUTTING AND PATCHING**

##### **A. CHASES AND OPENINGS**

1. The Contractor is responsible for the provision and/or coordination of all chases, openings and recesses required by work of his own forces, subcontractors or separate contractors.
  - a) Each subcontractor or separate contractor shall be responsible for furnishing advance information to the General Contractor as to exact dimensions and locations of such chases and openings, and shall provide and set in place all necessary sleeves, inserts and forms.
  - b) Openings shall be accurately located, neatly cut, and no larger than necessary. Provide all rebuilding, patching, refinishing and painting required to restore the construction to original condition.
2. Provide shoring, bracing, and support as required to maintain structural integrity of the project.
3. Provide protection from cutting and patching operations as required for other portions of the project; protect the Work and existing improvements in proximity to the cutting and patching operations from the elements.

#### **SECTION 017419 – CONSTRUCTION WASTE MANAGEMENT & DISPOSAL**

##### **A. PERIODIC CLEANING**

1. Each Contractor shall clean up after his own work as needed and/or ensure that sub-contractors clean up after their work and remove accumulations of waste, debris, and rubbish caused by construction operations.
  - a) Remove all waste, rubbish and debris on a daily basis (if needed), as they accumulate, and after completion of the Work.

##### **B. PROJECT COMPLETION**

1. On completion of the project, the entire job shall be cleaned up and left in perfect condition, including adjacent areas.
  - a) Marred surfaces shall be patched or repaired and touched up to match adjoining surfaces.
  - b) All rubbish shall be removed from the site before acceptance.
  - c) New surfaces and/or exposed elements of the Work shall be protected from stain and marring. These surfaces shall be cleaned to the satisfaction of the Owner's Representative or replaced if said stains or mars are unable to be completely removed

##### **C. GOVERNMENTAL REGULATIONS**

1. Conduct cleaning and disposal operations in compliance with Federal, State and local ordinances and anti-pollution laws and regulations.

#### **SECTION 017700 - PROJECT CLOSEOUT**

##### **A. GENERAL**

Work includes:

1. Substantial Completion.
2. Final Completion
3. Closeout submittals.
4. Instruction

##### **B. SUBSTANTIAL COMPLETION**

1. Prepare and submit the list ("punch-list") required by the first sentence of Paragraph 9.8.2 of the General Conditions.
  - a) Within a reasonable time after receipt of the list the Owner's Representative will inspect to determine status of completion. Should the Owner's Representative determine that the Work is not Substantially Complete:
    - 1) The Owner's Representative will so notify the Contractor, in writing, giving the reasons therefore.
    - 2) Remedy the deficiencies and notify the Owner's Representative when ready for reinspection.
    - 3) The Owner's Representative will reinspect the Work.
  - b) When the Owner's Representative concurs that the Work is Substantially Complete:
    - 1) The Owner's Representative will prepare a "Certificate of Substantial Completion" on AIA form G704, accompanied by the Contractor's list of items to be completed or corrected, as verified and approved by the Owner's Representative.
    - 2) The Owner's Representative will submit the Certificate to the Owner and to the Contractor for their written acceptance of the responsibilities assigned to them in the Certificate.

##### **C. FINAL COMPLETION**

1. Prepare and submit the notice required by the first sentence of Paragraph 9.10.1 of the General Conditions.
  - a) Verify that the Work is complete including, but not necessarily limited to, the items mentioned in Paragraph 9.8.2 of the General Conditions. Certify that:
    - 1) the Contract Documents have been reviewed;
    - 2) the Work has been inspected for compliance with the Contract Documents;
    - 3) the Work has been completed in accordance with the Contract Documents;
    - 4) equipment and systems have been tested as required, and are operational;
    - 5) the Work is completed and ready for final inspection.
  - b) The Owner's Representative will make a final inspection to verify status of completion and if all "punch-list" items have been completed, and upon receipt of the Contractor's Final Application for Payment, issue a Certificate of Final Completion. Should the Owner's Representative determine that the Work is incomplete or defective:
    - 1) The Owner's Representative will so notify the Contractor, in writing, listing the incomplete or defective work.
    - 2) Remedy the deficiencies promptly, and notify the Owner's Representative when ready for reinspection.
  - c) **FINAL APPLICATION FOR PAYMENT**
    - 1) Submit a final Application for Payment to the Owner's Representative, showing all adjustments to the Contract Sum.

- 2) If needed, the Owner's Representative will prepare a final Change Order showing adjustments to the Contract Sum which were not made previously by Change Orders.
- 3) Include final waivers of lien from the Contractor, sub-contractors, and major suppliers.
- 4) Final payment will not be released until all close-out submittals have been made, final cleaning has been performed, and required instruction(s) to Owner's personnel have been accomplished.

**D. CLOSEOUT SUBMITTALS**

1. When the Owner's Representative determines that the Work is acceptable under the Contract Documents, he will request the Contractor to make closeout submittals. Closeout submittals include, but are not necessarily limited to:
  - a) Project record documents described in "Section 017839".
  - b) Operation and maintenance manuals/data as described in "Section 017823".
  - c) Warranties and bonds as described in "Section 016000".
  - d) Keys and keying schedule;
  - e) Spare parts and materials extra stock;
  - f) Evidence of compliance with requirements of governmental agencies having jurisdiction including, but not necessarily limited to:
    - 1) Certificates of Inspection, as required
    - 2) Certificate(s) of Occupancy
  - g) Certificates of Insurance for products and completed operations;
  - h) Evidence of payment and release of liens.
    - 1) Consent of Surety to Final Payment
    - 2) Contractor's Final Waiver of Lien
    - 3) Separate releases or Waivers of Lien for sub-contractors, suppliers and others with lien rights against the Owner, together with a list of those parties.
  - i) List of subcontractors, service organizations, and principal vendors, including names, addresses, and telephone numbers where they can be reached for emergency service at all times including nights, weekends, and holidays.

**SECTION 017823 - OPERATING/MAINTENANCE MANUALS & INSTRUCTION**

**A. GENERAL**

1. Compile operating/product data and related information appropriate for Owner's maintenance and operation of products and equipment provided under the Contract.
2. Instruct Owner's personnel in operation and maintenance of products, equipment and systems.
3. OPERATIONS AND MAINTENANCE DATA REQUIRED:
  - a) Operating and maintenance manuals are required for each area of Work which is listed below, if that area of Work is included within the scope of Work of the project:
    - 1) HVAC
    - 2) Plumbing – including water supply, sewage and waste disposal
    - 3) Electrical
    - 4) Landscape irrigation system
    - 5) Fire sprinkler system
    - 6) Communications equipment and systems
    - 7) Materials and finishes

**B. OPERATIONS/MAINTENANCE MANUALS - FORM OF SUBMITTAL**

1. Prepare operating and maintenance manuals in the form of an instructional manual, utilizing heavy-duty, durable 3-ring vinyl covered loose-leaf binders, for use by the Owner's operating personnel. Organize into suitable sets of manageable size. Where possible, assemble instructions for similar equipment into a single binder. Provide when drawings or diagrams are required as part of the manual.
2. Provide sturdy manila or kraft envelope, accordion type file folder, or cardboard file boxes, properly labeled, of sufficient size to contain all submittals.
3. Submit one copy of data in final form at least fifteen days before final inspection. This copy will be returned within fifteen days after final inspection, with comments. After final inspection make corrections or modifications to comply with the Owner's Representative's comments and submit three copies of each approved manual to the Owner's Representative
4. WARRANTIES, BONDS AND SERVICE CONTRACTS
  - a) Provide a copy of each warranty, bond or service contract in the appropriate manual for the information of the Owner's operating personnel. Provide written data outlining procedures to be followed in the event of product failure. List circumstances and conditions that would affect validity of the warranty or bond. Provide list for each product containing name, address, and phone number of:
    - 1) Contractor.
    - 2) Subcontractor.
    - 3) Maintenance contractor, as appropriate.
    - 4) Local supply source for parts and replacement.
  - b) Identify area of responsibility of each contractor.

**C. MANUAL FOR MATERIALS AND FINISHES**

1. Submit two (2) copies of complete manual in final form.
2. Refer to individual Specification Sections for additional requirements on care and maintenance of materials and finishes.
3. Content for products, applied materials and finishes:
  - a) Manufacturer's data, giving full information on products.
    - 1) Catalog number, size, composition.
    - 2) Color and texture designations.
    - 3) Information for re-ordering special-manufactured products.
4. Instructions for care and maintenance.
  - a) Manufacturer's recommendations for types of cleaning agents and methods.

- b) Cautions against cleaning agents and methods detrimental to product.
  - c) Recommended cleaning and maintenance schedule.
  - 5. Moisture-Protection and Weather-Exposed Products: Provide complete manufacturer's data with instructions on inspection, maintenance and repair of products exposed to the weather or designed for moisture-protection purposes.
  - 6. Manufacturer's Data: Provide manufacturer's data giving detailed information, including the following, as applicable:
    - a) Applicable standards.
    - b) Chemical composition.
    - c) Installation details.
    - d) Inspection procedures.
    - e) Maintenance information.
    - f) Repair procedures.
- D. INSTRUCTION
- 1. Instruct the Owner's personnel in proper operation and maintenance of systems, equipment, and similar items which were provided as part of the Work including, but not limited to;
    - a) Mechanical
    - b) Water supply
    - c) Electrical service/distribution and lighting
    - d) Other items or systems as required in individual sections of the Technical Specifications
  - 2. Instructions for the Owner's Personnel: For instruction of the Owner's operating and maintenance personnel, use experienced instructors thoroughly trained and experienced in the operation and maintenance of the equipment or system involved.

**SECTION 017839 - PROJECT RECORD DOCUMENTS (AS-BUILTS)**

- A. DOCUMENTS REQUIRED AT SITE
  - 1. The Contractor shall maintain at the job site one copy of all Drawings, Specifications, Addenda, approved Shop Drawings, Change Orders, and other Contract modifications.
    - a) Each of these project record documents shall be clearly marked "**Project Record Copy**"
    - b) Shall be maintained in good condition
    - c) shall be available at all times for inspection by the Park District, and shall not be used for construction purposes.
- B. Project-record drawings shall be marked up to show significant changes made during construction progress, referenced to visible and accessible features of the structures. Project-record drawings shall be kept current and no work shall be concealed until required information has been recorded.
- C. Record-documents shall be submitted in satisfactory condition to the Park District at the completion of the project. **FINAL COMPLETION OF THE PROJECT WILL NOT BE ATTAINED, AND FINAL PAYMENT WILL BE WITHHELD, UNTIL PROJECT "AS-BUILTS" ARE SUBMITTED TO AND APPROVED BY THE OWNER'S REPRESENTATIVE.**

END OF GENERAL REQUIREMENTS



**ATTACHMENT A.6**  
**INSURANCE REQUIREMENTS**  
**ROUTINE CONSTRUCTION, MAINTENANCE AND REPAIR PROJECTS**

Contractor shall obtain insurance of the types and in the amounts listed below.

**A. COMMERCIAL GENERAL AND UMBRELLA LIABILITY INSURANCE**

Contractor shall maintain commercial general liability (CGL) and, if necessary, commercial umbrella insurance with a limit of not less than \$1,000,000 each occurrence. If such CGL insurance contains a general aggregate limit, it shall apply separately to this project/location.

CGL insurance shall be written on Insurance Services Office (ISO) occurrence form CG 00 01 10 93, or a substitute form providing equivalent coverage, and shall cover liability arising from premises, operations, independent contractors, products-completed operations, personal injury and advertising injury, and liability assumed under an insured contract (including the tort liability of another assumed in a business contract).

Owner shall be included as an insured under the CGL, using ISO additional insured endorsement CG 20 10 or a substitute providing equivalent coverage, and under the commercial umbrella, if any. This insurance shall apply as primary insurance with respect to any other insurance or self-insurance afforded to Owner.

There shall be no endorsement or modification of the CGL limiting the scope of coverage for liability arising from pollution, explosion, collapse, or underground property damage.

**B. CONTINUING COMPLETED OPERATIONS LIABILITY INSURANCE**

Contractor shall maintain commercial general liability (CGL) and, if necessary, commercial umbrella liability insurance with a limit of not less than \$1,000,000 each occurrence for at least one (1) year following substantial completion of the work.

Continuing CGL insurance shall be written on ISO occurrence form CG 00 01 10 93, or substitute form providing equivalent coverage, and shall, at minimum, cover liability arising from products-completed operations and liability assumed under an insured contract.

Continuing CGL insurance shall have a products-completed operations aggregate of at least two times its each occurrence limit.

Continuing commercial umbrella coverage, if any, shall include liability coverage for damage to the insured's completed work equivalent to that provided under ISO form CG 00 01.

**C. BUSINESS AUTO AND UMBRELLA LIABILITY INSURANCE**

Contractor shall maintain business auto liability and, if necessary, commercial umbrella liability insurance with a limit of not less than \$1,000,000 each accident. Such insurance shall cover liability arising out of any auto including owned, hired and non-owned autos.

Business auto insurance shall be written on Insurance Services Office (ISO) form CA 00 01, CA 00 05, CA 00 12, CA 00 20, or a substitute form providing equivalent liability coverage. If necessary, the policy shall be endorsed to provide contractual liability coverage equivalent to that provided in the 1990 and later editions of CA 00 01.

**D. WORKERS COMPENSATION INSURANCE**

Contractor shall maintain workers compensation as required by statute and employers liability insurance. The commercial umbrella and/or employers liability limits shall not be less than \$1,000,000 each accident for bodily injury by accident or \$1,000,000 each employee for bodily injury by disease.

If Owner has not been included as an insured under the CGL using ISO additional insured endorsement CG 20 10 under the Commercial General and Umbrella Liability Insurance required in this Contract, the Contractor waives all rights against Owner and its officers, officials, employees, volunteers and agents for recovery of damages arising out of or incident to the Contractor's work.

## **E. GENERAL INSURANCE PROVISIONS**

- 1. Evidence of Insurance.** Prior to beginning work, Contractor shall furnish Owner with a certificate(s) of insurance and applicable policy endorsement(s), executed by a duly authorized representative of each insurer, showing compliance with the insurance requirements set forth above.

All certificates shall provide for 30 days written notice to Owner prior to the cancellation or material change of any insurance referred to therein. Written notice to Owner shall be by certified mail, return receipt requested.

Failure of Owner to demand such certificate, endorsement or other evidence of full compliance with these insurance requirements or failure of Owner to identify a deficiency from evidence that is provided shall not be construed as a waiver of Contractor's obligation to maintain such insurance.

Owner shall have the right, but not the obligation, of prohibiting Contractor or any subcontractor from entering the project site until such certificates or other evidence that insurance has been placed in complete compliance with these requirements is received and approved by Owner.

Failure to maintain the required insurance may result in termination of this Contract at Owner's option.

With respect to insurance maintained after final payment in compliance with a requirement above, an additional certificate(s) evidencing such coverage shall be promptly provided to Owner whenever requested.

Contractor shall provide certified copies of all insurance policies required above within 10 days of Owner's written request for said copies.

- 2. Acceptability of Insurers.** For insurance companies which obtain a rating from A.M. Best, that rating should be no less than A VII using the most recent edition of the A.M. Best's Key Rating Guide. If the Best's rating is less than A VII or a Best's rating is not obtained, the Owner has the right to reject insurance written by an insurer it deems unacceptable.
- 3. Cross-Liability Coverage.** If Contractor's liability policies do not contain the standard ISO separation of insureds provision, or a substantially similar clause, they shall be endorsed to provide cross-liability coverage.
- 4. Deductibles and Self-Insured Retentions.** Any deductibles or self-insured retentions must be declared to the Owner. At the option of the Owner, the Contractor may be asked to eliminate such deductibles or self insured retentions as respects the Owner, its officers, officials, employees, volunteers and agents or required to procure a bond guaranteeing payment of losses and other related costs including but not limited to investigations, claim administration and defense expenses.
- 5. Subcontractors.** Contractor shall cause each subcontractor employed by Contractor to purchase and maintain insurance of the type specified above. When requested by the Owner, Contractor shall furnish copies of certificates of insurance evidencing coverage for each subcontractor.

## **F. INDEMNIFICATION**

To the fullest extent permitted by law, the Contractor shall indemnify and hold harmless the Owner and the Architect and their officers, officials, employees, volunteers and agents from and against all claims, damages, losses and expenses including but not limited legal fees (attorney's and paralegal's fees and court costs), arising

out of or resulting from the performance of the Contractor's work, provided that any such claim, damage, loss or expense (1) is attributable to bodily injury, sickness, disease or death, or injury to or destruction of tangible property, other than the work itself, including the loss of use resulting therefrom and (2) is caused in whole or in part by any wrongful or negligent act or omission of the Contractor, any Subcontractor, anyone directly or indirectly employed by any of them or anyone for whose acts any of them may be liable, except to the extent it is caused in part by a party indemnified hereunder. Such obligation shall not be construed to negate, abridge, or otherwise reduce any other right or obligation of indemnity which would otherwise exist as to any party or person described in this Paragraph. Contractor shall similarly protect, indemnify and hold and save harmless the Owner, its officers, officials, employees, volunteers and agents against and from any and all claims, costs, causes, actions and expenses including but not limited to legal fees, incurred by reason of Contractor's breach of any of its obligations under, or Contractor's default of, any provision of the Contract.

## SAMPLE LIABILITY INSURANCE ENDORSEMENT

**The following spaces preceded by an asterisk (\*) need not be completed if this endorsement and policy have the same inception date.**

ATTACHED TO AND FORMING PART OF POLICY NUMBER	*EFFECTIVE DATE OF ENDORSEMENT	*ISSUED TO
--	-----------------------------------	------------

This endorsement changes the policy. Please read it carefully.

### AUTOMATIC ADDITIONAL INSURED

The following provision is added to (SECTION II), Who Is An Insured.

5. Any entity you are required in a written contract (hereinafter called Additional Insured) to name as an insured is an insured but only with respect to liability arising out of your premises, "your work" for the Additional Insured, or acts or omissions of the Additional Insured in connection with the general supervision of "your work" to the extent set forth below.
  - a. The Limits of Insurance provided on behalf of the Additional Insured are not greater than those required by such contract.
  - b. The coverage provided to the Additional Insured(s) is not greater than that customarily provided by the policy forms specified in and required by the contract.
  - c. All insuring agreements, exclusions and conditions of this policy apply.
  - d. In no event shall the coverages or Limits of Insurance in this Coverage Form be increased by such contract.

Except when required otherwise by contract, this insurance does not apply to:

- 1) "Bodily injury" or "property damage" occurring after
  - a) All work on the project (other than service, maintenance or repairs) to be performed by or on behalf of the Additional Insured(s) at the site of the covered operations has been completed; or
  - b) That portion of "your work" out of which the injury or damage arises has been put to its intended use by any person or organization other than another contractor or subcontractor engaged in performing operations for a principal as a part of the same project.
- 2) "Bodily injury" or "property damage" arising out of any act or omission of the Additional Insured(s) or any of their employees, other than the general supervision of work performed for the Additional Insured(s) by you.
- 3) "Property damage" to
  - a) Property owned, used or occupied by or rented to the Additional Insured(s);
  - b) Property in the care, custody or control of the Additional Insured(s) or over which the Additional Insured(s) is for any purpose exercising physical control; or

- c) “Your work” for the Additional Insured(s).

With respect to Additional Insureds who are architects, engineers or surveyors, this insurance does not apply “bodily injury”, “property damage”, “personal injury” or “advertising injury” arising out of the rendering of or the failure to render any professional services by or for you, including:

- a) The preparing, approving, or failing to prepare or approve maps, drawings, opinions, reports, surveys, change orders, designs or specifications; and
- b) Supervisory, inspection or engineering services.

Any coverages provided hereunder shall be excess over any other valid and collectible insurance available to the Additional Insured(s) whether primary, excess, contingent or on any other basis unless a contract specifically requires that this insurance be primary or you request that it apply on a primary basis.

No person or organization is an Additional Insured with respect to the conduct of any current or past partnership or joint venture that is not shown as a Named Insured in the Declarations.

END OF ATTACHMENT A.6

# CONSTRUCTION PLANS

FOR  
**CURB AND GUTTER IMPROVEMENTS NORTH/UPPER BRADLEY PARK**  
 PEORIA, ILLINOIS

Sheet List Table

C0.0	COVER SHEET
V1.1	EXISTING TOPOGRAPHY SURVEY - NORTH
V1.2	EXISTING TOPOGRAPHY SURVEY - SOUTH
C1.1	OVERALL SITE PLAN AND GENERAL NOTES
CD1.1	SITE REMOVAL PLAN - NORTH
CD1.2	SITE REMOVAL PLAN - SOUTH
C2.1	SITE GRADING PLAN - NORTH
C2.2	SITE GRADING PLAN - SOUTH
C3.1	STORM WATER POLLUTION PREVENTION PLAN, DETAILS AND NOTES

JOINT UTILITY LOCATION INFORMATION FOR EXCAVATORS

THE CONTRACTOR'S ATTENTION IS DIRECTED TO THE FACT THAT THERE EXISTS WITHIN THE STATE OF ILLINOIS A JOINT UTILITY LOCATION INFORMATION FOR EXCAVATORS (J.U.L.I.E.) SYSTEM. THE TELEPHONE NUMBER FOR THE UTILITY COMPANY IS: (800) 892-0123.

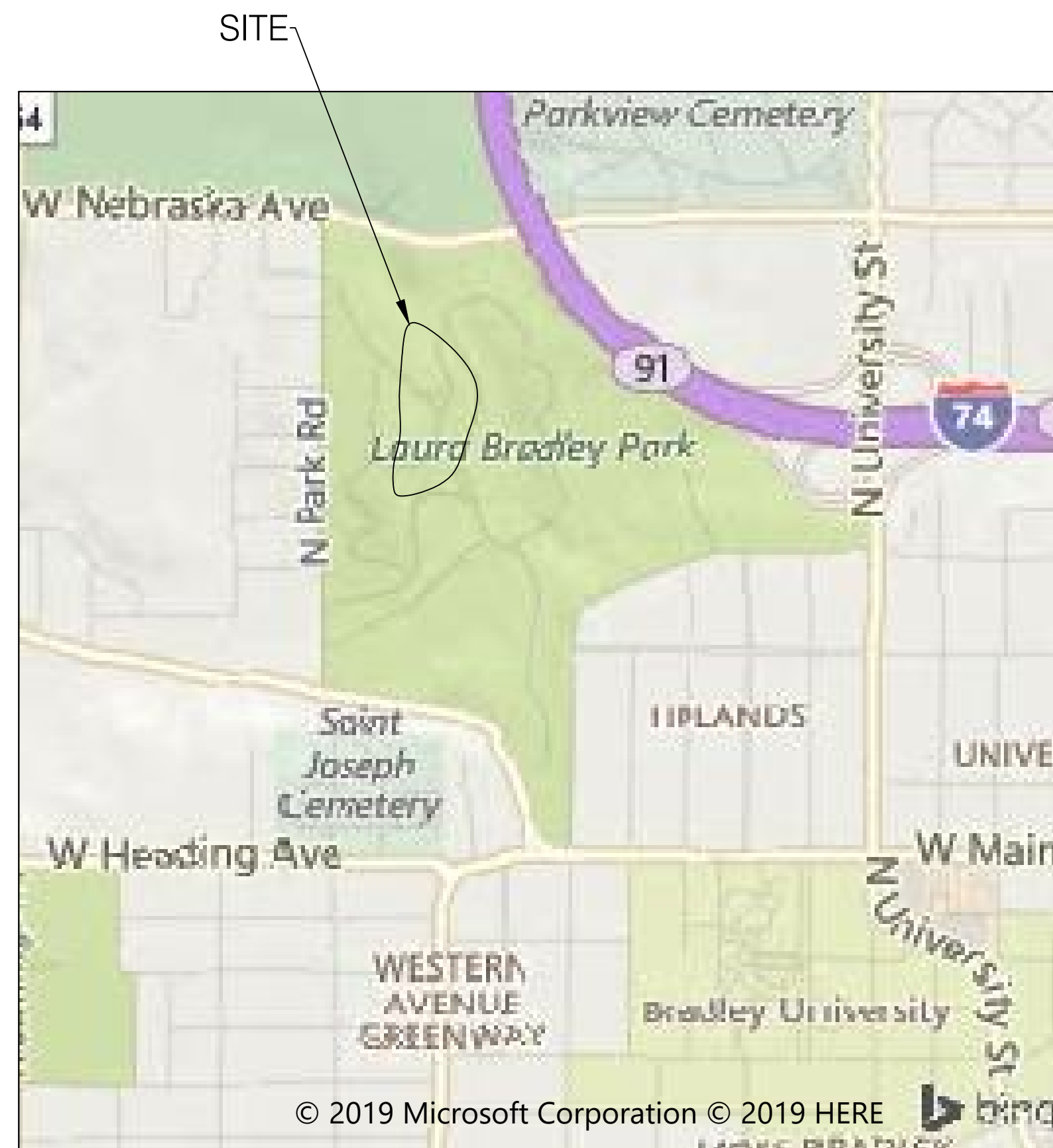

SITE LOCATION MAP  
 NTS

PREPARED BY : ZUMWALT & ASSOCIATES, INC.  
 1040 W OLYMPIA DRIVE  
 PEORIA, ILLINOIS 61615  
 (309) 692-5074

SUBMITTED BY: *Gary R. Zumwalt* DATE: MAY 19, 2020  
 GARY R. ZUMWALT



ILLINOIS REGISTERED PROFESSIONAL ENGINEER NO. 34277  
 DESIGN FIRM REGISTRATION NO. 184-003189

PREPARED FOR : PLEASURE DRIVEWAY AND PARK DISTRICT OF PEORIA, IL  
 PLANNING, DESIGN AND CONSTRUCTION DIVISION  
 1314 N. PARK ROAD  
 PEORIA, IL 61604  
 CONTACT: MARY HARDEN

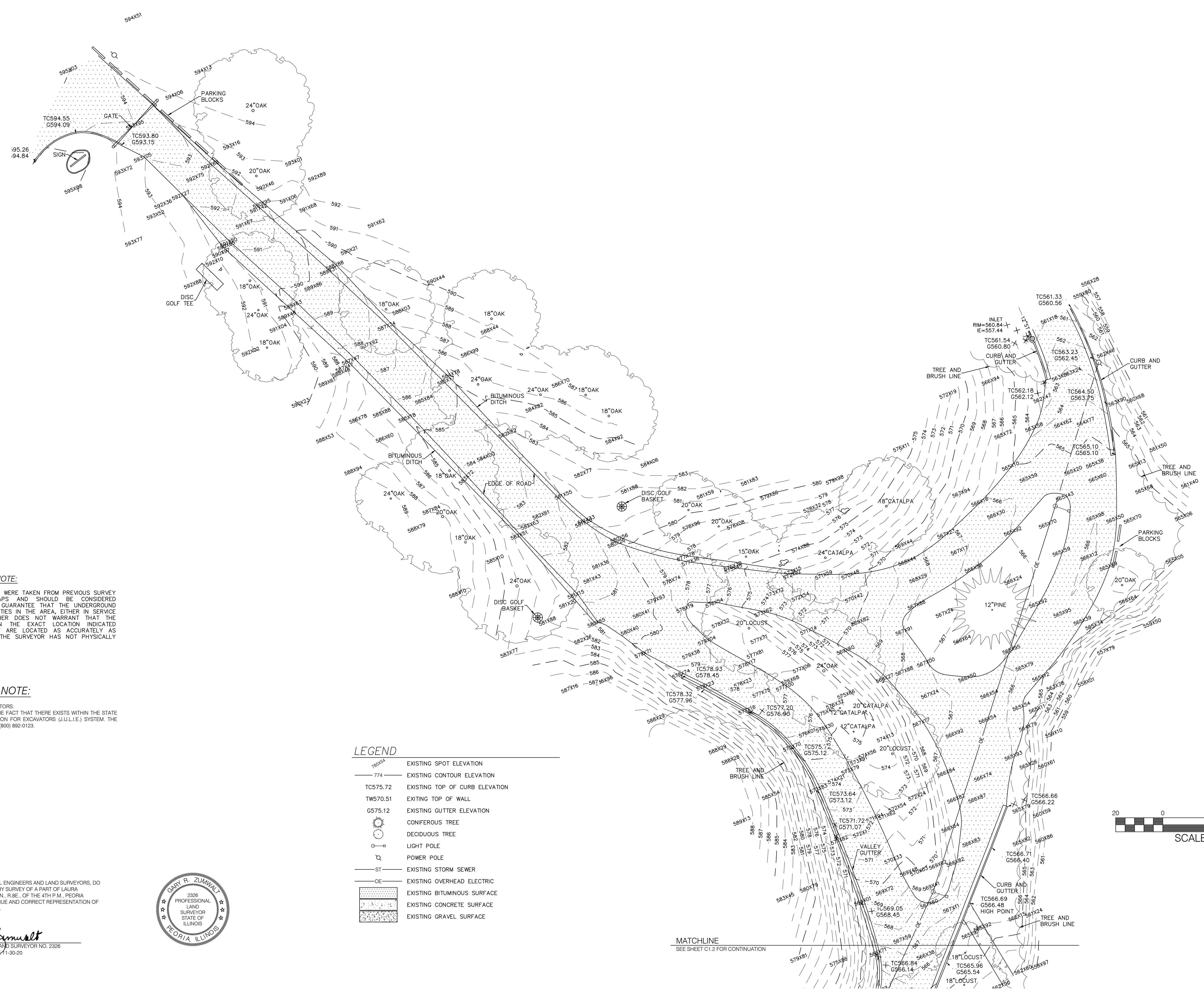

**UTILITY NOTE:**

UNDERGROUND UTILITIES AS SHOWN HEREON WERE TAKEN FROM PREVIOUS SURVEY INFORMATION OR UTILITY COMPANY MAPS AND SHOULD BE CONSIDERED APPROXIMATE. THE SURVEYOR MAKES NO GUARANTEE THAT THE UNDERGROUND UTILITIES SHOWN COMPRISE ALL SUCH UTILITIES IN THE AREA, EITHER IN SERVICE OR ABANDONED. THE SURVEYOR FURTHER DOES NOT WARRANT THAT THE UNDERGROUND UTILITIES SHOWN ARE IN THE EXACT LOCATION INDICATED ALTHOUGH HE DOES CERTIFY THAT THEY ARE LOCATED AS ACCURATELY AS POSSIBLE FROM INFORMATION AVAILABLE. THE SURVEYOR HAS NOT PHYSICALLY LOCATED THE UNDERGROUND UTILITIES.

**J.U.L.I.E. NOTE:**

JOINT UTILITY LOCATION INFORMATION FOR EXCAVATORS. THE CONTRACTORS ATTENTION IS DIRECTED TO THE FACT THAT THERE EXISTS WITHIN THE STATE OF ILLINOIS A JOINT UTILITY LOCATION INFORMATION FOR EXCAVATORS (J.U.L.I.E.) SYSTEM. THE TELEPHONE NUMBER FOR THE UTILITY COMPANY IS (800) 892-0123.

**LEGEND**

- 7850.24 EXISTING SPOT ELEVATION
- 774 EXISTING CONTOUR ELEVATION
- TC575.72 EXISTING TOP OF CURB ELEVATION
- TW570.51 EXISTING TOP OF WALL
- G575.12 EXISTING GUTTER ELEVATION
- CONIFEROUS TREE
- DECIDUOUS TREE
- LIGHT POLE
- POWER POLE
- ST EXISTING STORM SEWER
- OE EXISTING OVERHEAD ELECTRIC
- EXISTING BITUMINOUS SURFACE
- EXISTING CONCRETE SURFACE
- EXISTING GRAVEL SURFACE

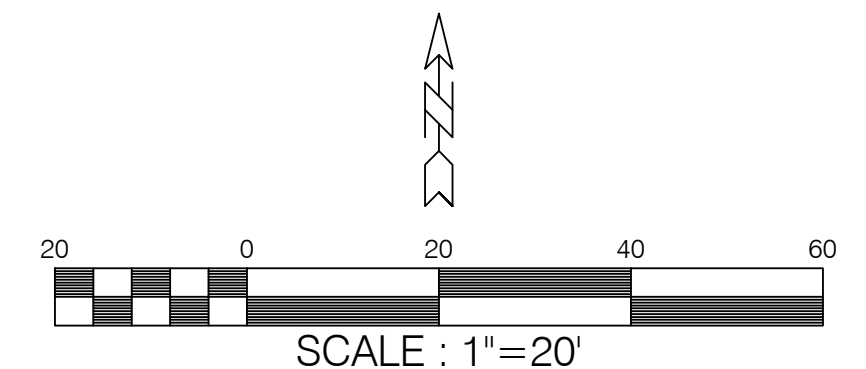

STATE OF ILLINOIS )  
COUNTY OF PEORIA )

WE, ZUMWALT AND ASSOCIATES, INC., PROFESSIONAL ENGINEERS AND LAND SURVEYORS, DO HEREBY CERTIFY THAT WE HAVE MADE A TOPOGRAPHY SURVEY OF A PART OF LAURA BRADLEY PARK, BEING A PART SECTIONS 5 AND 6, T.8N., R.8E., OF THE 4TH P.M., PEORIA COUNTY, ILLINOIS, AND THAT THE ABOVE PLAT IS A TRUE AND CORRECT REPRESENTATION OF SAID SURVEY AS DRAWN TO A SCALE OF 1" = 20 FEET.

DATED THIS 14TH DAY OF APRIL, 2020.

BY: *Gary R. Zumwalt*  
ILLINOIS PROFESSIONAL LAND SURVEYOR NO. 2326  
LICENSE EXPIRATION DATE: 11-30-20



MATCHLINE  
SEE SHEET C1.2 FOR CONTINUATION

PROJECT MANAGER: TWA	REVISIONS:
APPROVED BY: GRZ	
DATE: MAY 19, 2020	
DWG: 20867 - V1.1 SITE TOPOGRAPHY - NORTH	
SURVEY BY: MJF	

**ZUMWALT & ASSOCIATES, INC.**  
PROFESSIONAL ENGINEERS • REGISTERED LAND SURVEYORS  
1040 W. OLYMPIA DRIVE  
PEORIA, ILLINOIS • (309) 692-5074  
DESIGN FIRM REGISTRATION NO. 184-003189

**CURB AND GUTTER IMPROVEMENTS**  
NORTH/UPPER BRADLEY PARK  
PEORIA, ILLINOIS

EXISTING TOPOGRAPY SURVEY - NORTH

SHT. NO.  
**V1.1**



JOB NO. 20.867

©COPYRIGHT 2020 ZUMWALT & ASSOCIATES, INC.  
THIS DOCUMENT IS THE PROPERTY OF ZUMWALT & ASSOCIATES, INC.  
ANY REPRODUCTION OR UNAUTHORIZED USE IS STRICTLY PROHIBITED

**UTILITY NOTE:**

UNDERGROUND UTILITIES AS SHOWN HEREON WERE TAKEN FROM PREVIOUS SURVEY INFORMATION OR UTILITY COMPANY MAPS AND SHOULD BE CONSIDERED APPROXIMATE. THE SURVEYOR MAKES NO GUARANTEE THAT THE UNDERGROUND UTILITIES SHOWN COMPRISE ALL SUCH UTILITIES IN THE AREA, EITHER IN SERVICE OR ABANDONED. THE SURVEYOR FURTHER DOES NOT WARRANT THAT THE UNDERGROUND UTILITIES SHOWN ARE IN THE EXACT LOCATION INDICATED ALTHOUGH HE DOES CERTIFY THAT THEY ARE LOCATED AS ACCURATELY AS POSSIBLE FROM INFORMATION AVAILABLE. THE SURVEYOR HAS NOT PHYSICALLY LOCATED THE UNDERGROUND UTILITIES.

**J.U.L.I.E. NOTE:**

JOINT UTILITY LOCATION INFORMATION FOR EXCAVATORS. THE CONTRACTOR'S ATTENTION IS DIRECTED TO THE FACT THAT THERE EXISTS WITHIN THE STATE OF ILLINOIS A JOINT UTILITY LOCATION INFORMATION FOR EXCAVATORS (J.U.L.I.E.) SYSTEM. THE TELEPHONE NUMBER FOR THE UTILITY COMPANY IS (800) 892-0123.

STATE OF ILLINOIS )  
COUNTY OF PEORIA )

WE, ZUMWALT AND ASSOCIATES, INC., PROFESSIONAL ENGINEERS AND LAND SURVEYORS, DO HEREBY CERTIFY THAT WE HAVE MADE A TOPOGRAPHY SURVEY OF A PART OF LAURA BRADLEY PARK, BEING A PART SECTIONS 8 AND 6, T.8N., R.8E., OF THE 4TH P.M., PEORIA COUNTY, ILLINOIS, AND THAT THE ABOVE PLAT IS A TRUE AND CORRECT REPRESENTATION OF SAID SURVEY AS DRAWN TO A SCALE OF 1" = 20 FEET.

DATED THIS 14TH DAY OF APRIL, A.D. 2020.

BY Gary R. Zumwalt  
ILLINOIS PROFESSIONAL LAND SURVEYOR NO. 2326  
LICENSE EXPIRATION DATE 11-30-20

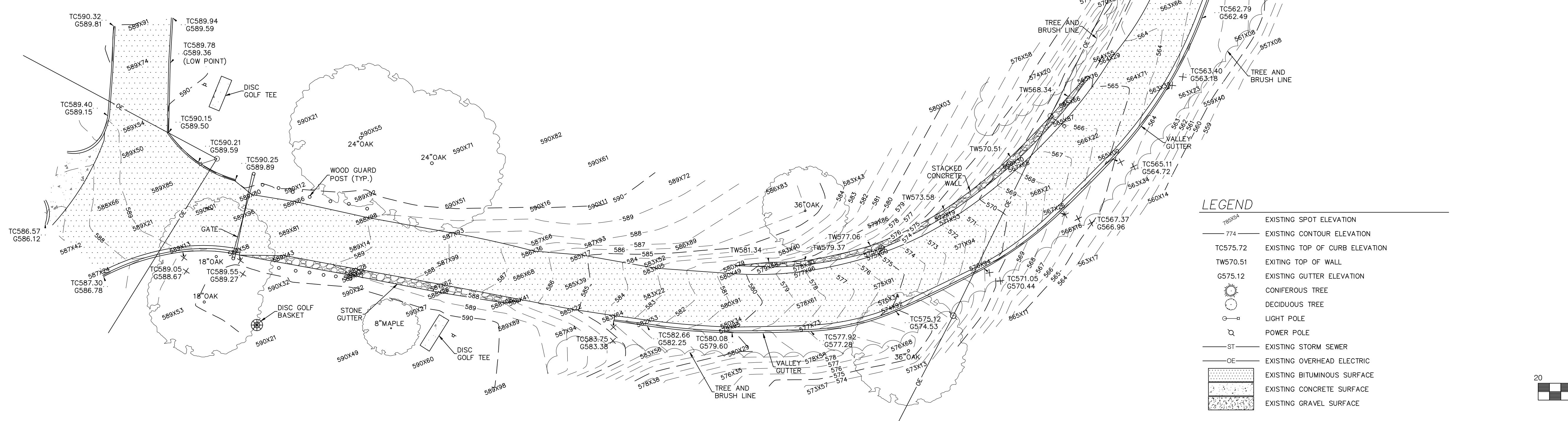

**LEGEND**

	EXISTING SPOT ELEVATION
	EXISTING CONTOUR ELEVATION
	EXISTING TOP OF CURB ELEVATION
	EXISTING TOP OF WALL
	EXISTING GUTTER ELEVATION
	CONIFEROUS TREE
	DECIDUOUS TREE
	LIGHT POLE
	POWER POLE
	EXISTING STORM SEWER
	EXISTING OVERHEAD ELECTRIC
	EXISTING BITUMINOUS SURFACE
	EXISTING CONCRETE SURFACE
	EXISTING GRAVEL SURFACE

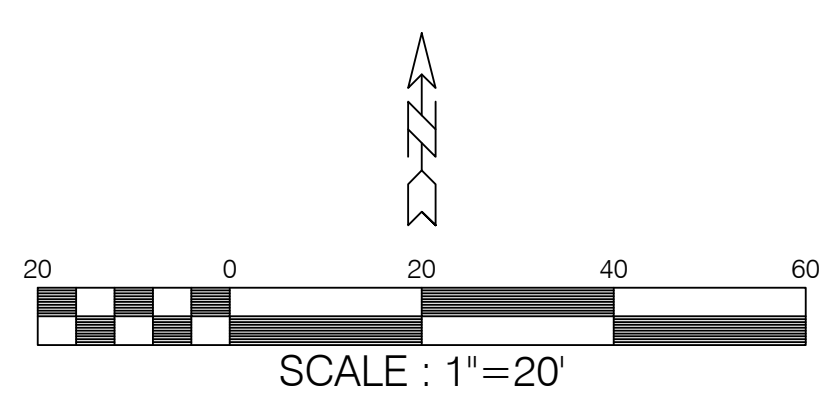

PROJECT MANAGER: TWA
APPROVED BY: GRZ
DATE: MAY 19, 2020
DWG: 20867 - V1.2 SITE TOPOGRAPHY - SOUTH
SURVEY BY: MJF

REVISIONS:

**ZUMWALT & ASSOCIATES, INC.**  
PROFESSIONAL ENGINEERS • REGISTERED LAND SURVEYORS  
1040 W. OLYMPIA DRIVE  
PEORIA, ILLINOIS • (309) 692-5074  
DESIGN FIRM REGISTRATION NO. 184-003189

**CURB AND GUTTER IMPROVEMENTS**  
NORTH/UPPER BRADLEY PARK  
PEORIA, ILLINOIS

EXISTING TOPOGRAPHY SURVEY - SOUTH

SHT. NO.  
**V1.2**



JOB NO. 20.867

©COPYRIGHT 2020 ZUMWALT & ASSOCIATES, INC.  
THIS DOCUMENT IS THE PROPERTY OF ZUMWALT & ASSOCIATES, INC.  
ANY REPRODUCTION OR UNAUTHORIZED USE IS STRICTLY PROHIBITED



**GENERAL NOTES**

- SEE CONSTRUCTION NOTES ON OTHER "C" DRAWINGS FOR OTHER CONDITIONS AFFECTING CONSTRUCTION WORK.
- THE CONTRACTOR SHALL VERIFY THE LOCATION OF ALL UTILITIES IN THE FIELD PRIOR TO COMMENCING WORK.
- THE CONTRACTOR SHALL ACQUIRE ALL PERMITS THAT ARE REQUIRED BY THE LOCAL AUTHORITIES AND ALL CONSTRUCTION WORK SHALL BE PERFORMED IN COMPLIANCE WITH THE REQUIREMENTS OF ALL APPLICABLE LOCAL, STATE, AND FEDERAL LAWS, REGULATIONS AND RULES.
- ALL CONSTRUCTION WORK SHALL BE IN ACCORDANCE WITH:
  - STATE OF ILLINOIS STANDARD SPECIFICATIONS FOR ROAD AND BRIDGE CONSTRUCTION
  - STANDARD SPECIFICATIONS FOR WATER AND SEWER MAIN CONSTRUCTION IN ILLINOIS
- STORM WATER POLLUTION PREVENTION PLAN. CONTRACTOR SHALL PROVIDE EROSION CONTROL, PROTECTION DURING UTILITY AND CONSTRUCTION WORK IN ACCORDANCE WITH THE STORM WATER POLLUTION PREVENTION PLAN, EROSION CONTROL DETAILS AND NOTES SHOWN ON SHEET C3.1.
- EXCAVATION PLACED IN STRUCTURAL FILL AREAS AND SUBGRADES IN PAVEMENT AREAS SHALL BE COMPACTED TO 98 PERCENT AS DETERMINED BY STANDARD PROCTOR.
- APPROXIMATELY 8 INCHES OF TOP SOIL SHALL BE STRIPPED IN ALL STRUCTURAL AREAS. THE EXACT AMOUNT TO BE DETERMINED BY THE OWNER'S REPRESENTATIVE. A MINIMUM OF 6 INCHES OF TOPSOIL SHALL BE PLACED IN ALL DISTURBED AREAS. AFTER CONSTRUCTION OF CURB AND GUTTER AND BEHIND CURBS SHALL BE BACKFILLED WITH TOPSOIL AND SHALL BE GRADED TO DRAIN. CONTRACTOR SHALL REQUEST AND RECEIVE WRITTEN APPROVAL FROM THE OWNER FOR ANY ADDITIONAL WORK PRIOR TO COMMENCEMENT OF SAID WORK. NO ADDITIONAL WORK BY THE CONTRACTOR WILL BE AUTHORIZED UNTIL A CHANGE ORDER IS SIGNED BY THE OWNER.
- DUST CONTROL SHALL BE PROVIDED BY WATERING OR OTHER MEANS TO KEEP DUST TO A MINIMUM DURING CONSTRUCTION.
- ALL EXISTING ADJACENT AREAS AND PROPERTY SHALL BE PROPERLY PROTECTED FROM DAMAGE AND LEFT UNDEGRADED FROM THE OPERATIONS OF THE CONTRACTOR. ANY OF THE SURROUNDING PROPERTY DAMAGED BY THE CONTRACTOR SHALL BE REPLACED TO AN EQUAL OR BETTER CONDITION THAN WHAT EXISTED PRIOR AT THE CONTRACTOR'S EXPENSE.
- THE CONTRACTOR SHALL NOTIFY THE OWNER'S REPRESENTATIVE 48 HOURS IN ADVANCE OF ANY PROPOSED CONSTRUCTION WORK.
- ALL UTILITY TRENCHES IN STRUCTURAL AREAS SHALL RECEIVE TRENCH BACKFILL AND SHALL BE COMPACTED TO 98 PERCENT AS DETERMINED BY STANDARD PROCTOR.
- ALL PRECAUTIONS SHALL BE TAKEN TO PREVENT TRACKING OF MATERIAL ONTO EXISTING ROADS DURING ALL PHASES OF CONSTRUCTION. THIS SHALL INCLUDE CLEANING OF MUD AND SEDIMENT OFF OF TRUCKS BEFORE LEAVING THE SITE AND CLEANING EXISTING PAVEMENT OF ALL DIRT, MUD AND DEBRIS AT THE END OF EACH DAYS WORK. CLEANING PAVEMENTS MORE FREQUENTLY SHALL ALSO OCCUR WHEN NECESSARY.
- ALL CONCRETE SHALL HAVE A MINIMUM ALLOWABLE COMPRESSIVE STRENGTH OF 4000 P.S.I. (28 DAYS). ALL CONCRETE WORK AND MATERIALS SHALL BE IN ACCORDANCE WITH THE REQUIREMENTS OF SECTION 420 OF THE STATE OF ILLINOIS STANDARD SPECIFICATIONS FOR ROAD AND BRIDGE CONSTRUCTION (LATEST EDITION). CONCRETE JOINT SEALING SHALL BE IN ACCORDANCE WITH THE REQUIREMENTS OF SEC. 420.12 OF THE STATE OF ILLINOIS STANDARD SPECIFICATIONS FOR ROAD AND BRIDGE CONSTRUCTION.
- THE CONTRACTOR SHALL MAKE ADJUSTMENTS TO THE REMOVAL AS NECESSARY TO CONSTRUCT THE PROPOSED CURB AND GUTTER. ANY BITUMINOUS PATCHING NEEDED BETWEEN THE EXISTING PAVEMENT REMAINING AND THE PROPOSED CURB AND GUTTER SHALL MATCH EXISTING DEPTH WITH A MINIMUM TO BE AS FOLLOWS:
  - 8" C.A. 6" TYPE "B" BASE COURSE
  - 4" BITUMINOUS SURFACE COURSE
- THE CONTRACTOR SHALL BE RESPONSIBLE FOR PROVIDING BARRICADES, TRAFFIC CONTROL, SIGNAGE AND OTHER SAFETY MEASURES FOR CLOSING ROADS FOR ANY PROPOSED IMPROVEMENT CONSTRUCTION AND RELATED ACTIVITIES. CONTRACTOR SHALL COORDINATE SCHEDULE AND TRAFFIC CONTROL MEASURES WITH OWNER 48 HOURS PRIOR TO ROAD SHUT DOWN AND COMMENCEMENT OF CONSTRUCTION.
- EXISTING FRISBEE GOLF COURSE ADJACENT TO PROJECT WILL BE REMAIN OPEN DURING CONSTRUCTION.

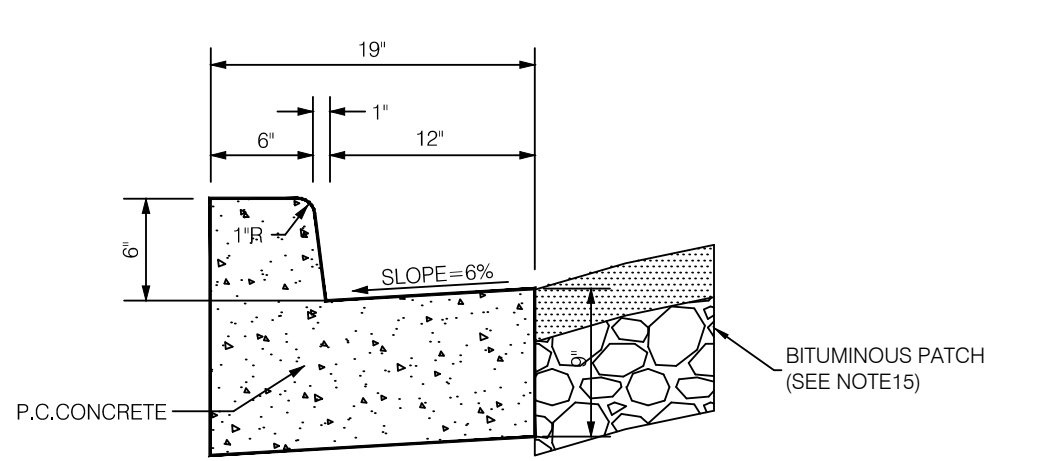

NOTE: CONTRACTION JOINTS ON THE PROPOSED CURB AND GUTTER SHALL BE MADE BY SAWING AT INTERVALS OF NOT MORE THAN 15 FEET. SAW CUT TO BE NOT LESS THAN 2" DEEP. NO DOWEL BARS REQUIRED.

**1 B-6.12 CURB AND GUTTER**  
N.T.S.

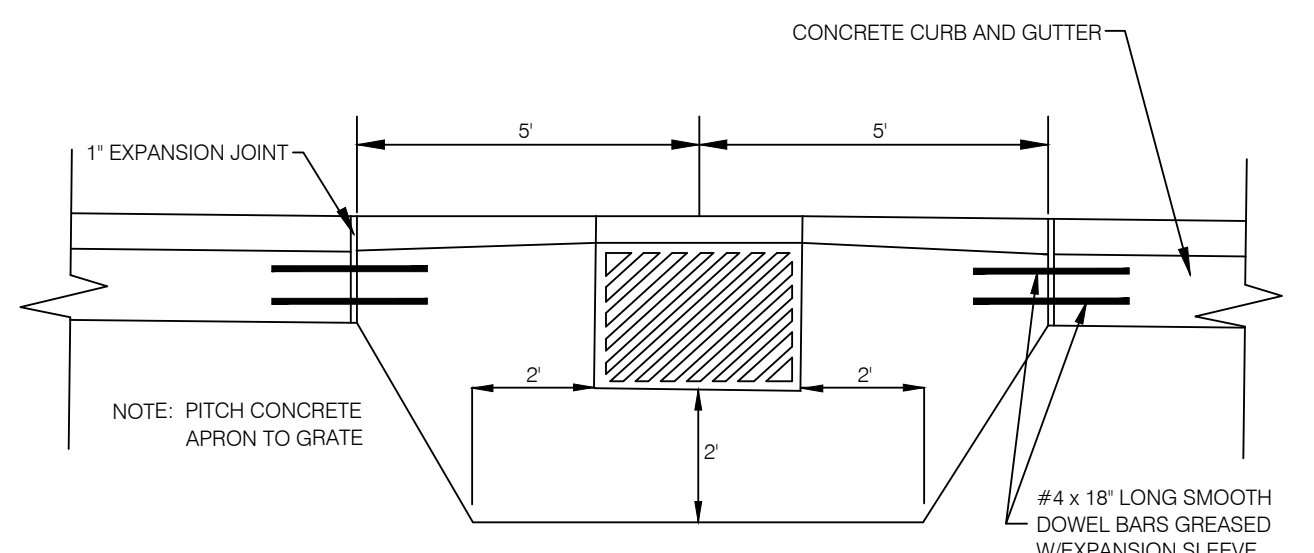

**2 CURB INLET APRON DETAIL**  
N.T.S.

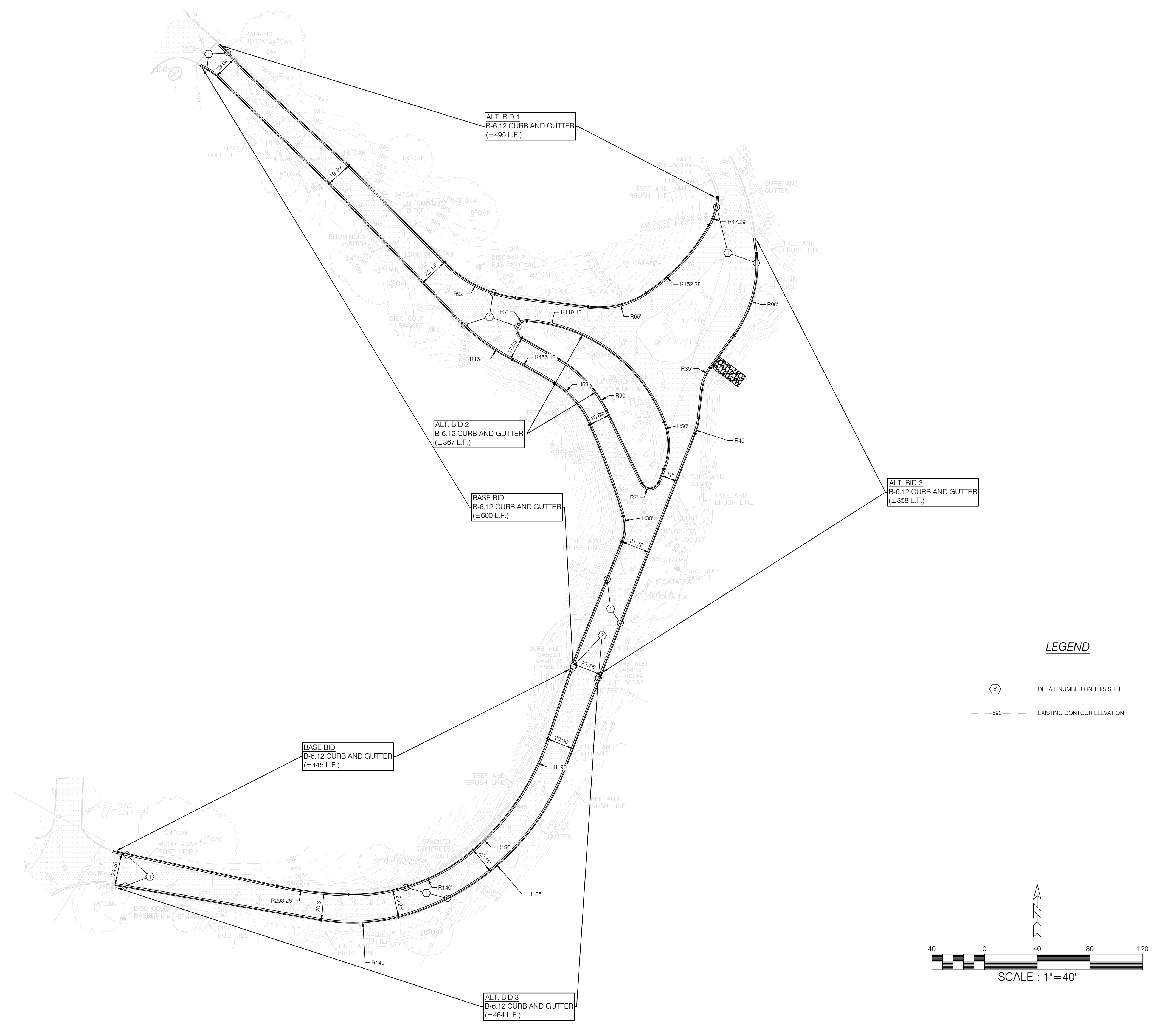

**LEGEND**

- (X) DETAIL NUMBER ON THIS SHEET
- - 590 - - EXISTING CONTOUR ELEVATION

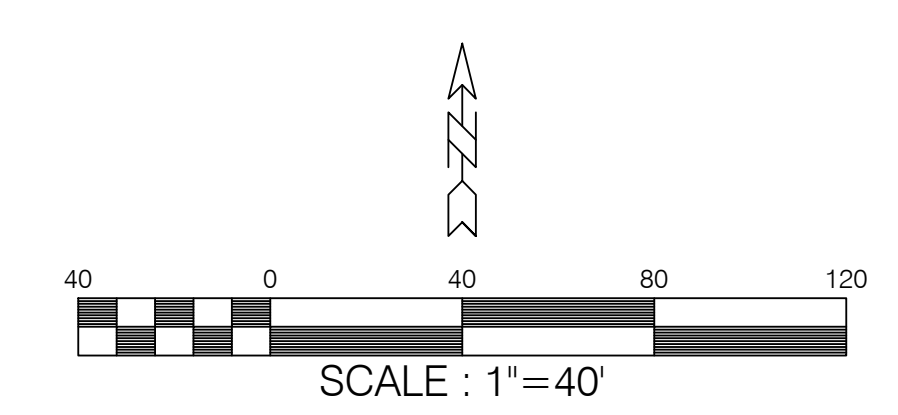

PROJECT MANAGER: TWA
APPROVED BY: GRZ
DATE: MAY 19, 2020
DWG: 20867 - C1.1 OVERALL SITE PLAN
SURVEY BY: MJF

REVISIONS:

**ZUMWALT & ASSOCIATES, INC.**  
 PROFESSIONAL ENGINEERS • REGISTERED LAND SURVEYORS  
 1040 W. OLYMPIA DRIVE  
 PEORIA, ILLINOIS • (309) 692-5074  
 DESIGN FIRM REGISTRATION NO. 184-003189

**CURB AND GUTTER IMPROVEMENTS**  
 NORTH/UPPER BRADLEY PARK  
 PEORIA, ILLINOIS

**OVERALL SITE PLAN AND GENERAL NOTES**

SHT. NO.  
**C1.1**



JOB NO. 20.867

**REMOVAL NOTES**

- SEE GENERAL NOTES ON SHEET CD1.1 FOR OTHER CONDITIONS AFFECTING CONSTRUCTION WORK.
- ALL REMOVAL ITEMS SHALL BE PROPERLY DISPOSED OF OFFSITE AT A LOCATION ACQUIRED BY THE CONTRACTOR UNLESS OTHERWISE NOTED.
- UTILITY COMPONENTS TO BE REMOVED OR RELOCATED SHALL BE PERFORMED BY THE UTILITY COMPANY HAVING OWNERSHIP. THE CONTRACTOR SHALL WORK WITH THE UTILITY COMPANIES FOR SCHEDULING, COORDINATION AND LOCATION OF ANY RELOCATION.
- CONTRACTOR SHALL NOTIFY THE OWNER 48 HOURS IN ADVANCE OF ANY PROPOSED CONSTRUCTION WORK.
- THE CONTRACTOR SHALL MAKE ADJUSTMENTS TO THE REMOVAL AS NECESSARY TO CONSTRUCT THE PROPOSED CURB AND ANY BITUMINOUS PATCHING NEEDED BETWEEN THE EXISTING PAVEMENT REMAINING AND THE PROPOSED CURB SHALL BE AS FOLLOWS:  
 BITUMINOUS PATCH  
 4" BITUMINOUS SURFACE COURSE  
 8" C&G TYPE B BASE COURSE  
 ALL TREE REMOVAL SHALL BE BY OWNER.
- BITUMINOUS PAVEMENT REMOVAL SHALL INCLUDE COMPLETELY REMOVING ALL BITUMINOUS PAVEMENT AND BASE COURSE DOWN TO SUBGRADE.
- EXISTING STONE VALLEY GUTTER TO BE REMOVED AT LOCATIONS SHOWN FOR CONSTRUCTION OF CURB AND GUTTER. ALL STONE SHALL BE STOCKPILED ADJACENT TO THE JOBSITE FOR SALVAGE BY THE OWNER.
- THE CONTRACTOR SHALL BE RESPONSIBLE FOR PROVIDING BARRICADES, TRAFFIC CONTROL, SIGNAGE AND OTHER SAFETY MEASURES FOR CLOSING ROAD FOR PROPOSED IMPROVEMENT CONSTRUCTION AND ANY RELATED CONSTRUCTION ACTIVITIES. CONTRACTOR SHALL COORDINATE SCHEDULE AND TRAFFIC CONTROL MEASURES WITH OWNER 48 HOURS PRIOR TO ROAD SHUTDOWN AND COMMENCEMENT OF CONSTRUCTION.

**LEGEND**

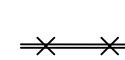
-  BITUMINOUS PAVEMENT/DITCH REMOVAL (SEE NOTE 7)
-  PC CONCRETE CURB REMOVAL









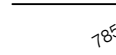
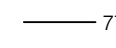

**UTILITY NOTE:**

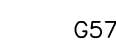
UNDERGROUND UTILITIES AS SHOWN HEREON WERE TAKEN FROM PREVIOUS SURVEY INFORMATION OR UTILITY COMPANY MAPS AND SHOULD BE CONSIDERED APPROXIMATE. THE SURVEYOR MAKES NO GUARANTEE THAT THE UNDERGROUND UTILITIES SHOWN COMPRISE ALL SUCH UTILITIES IN THE AREA, EITHER IN SERVICE OR ABANDONED. THE SURVEYOR FURTHER DOES NOT WARRANT THAT THE UNDERGROUND UTILITIES SHOWN ARE IN THE EXACT LOCATION INDICATED ALTHOUGH HE DOES CERTIFY THAT THEY ARE LOCATED AS ACCURATELY AS POSSIBLE FROM INFORMATION AVAILABLE. THE SURVEYOR HAS NOT PHYSICALLY LOCATED THE UNDERGROUND UTILITIES.

**J.U.L.I.E. NOTE:**

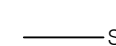
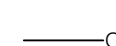
JOINT UTILITY LOCATION INFORMATION FOR EXCAVATORS. THE CONTRACTORS ATTENTION IS DIRECTED TO THE FACT THAT THERE EXISTS WITHIN THE STATE OF ILLINOIS A JOINT UTILITY LOCATION INFORMATION FOR EXCAVATORS (J.U.L.I.E.) SYSTEM. THE TELEPHONE NUMBER FOR THE UTILITY COMPANY IS (800) 892-0123.

**LEGEND**

-  EXISTING SPOT ELEVATION
-  774 EXISTING CONTOUR ELEVATION
-  TC575.72 EXISTING TOP OF CURB ELEVATION
-  TW570.51 EXISTING TOP OF WALL
-  G575.12 EXISTING GUTTER ELEVATION
-  CONIFEROUS TREE
-  DECIDUOUS TREE
-  LIGHT POLE
-  POWER POLE
-  ST EXISTING STORM SEWER
-  OE EXISTING OVERHEAD ELECTRIC
-  EXISTING BITUMINOUS SURFACE
-  EXISTING CONCRETE SURFACE
-  EXISTING GRAVEL SURFACE

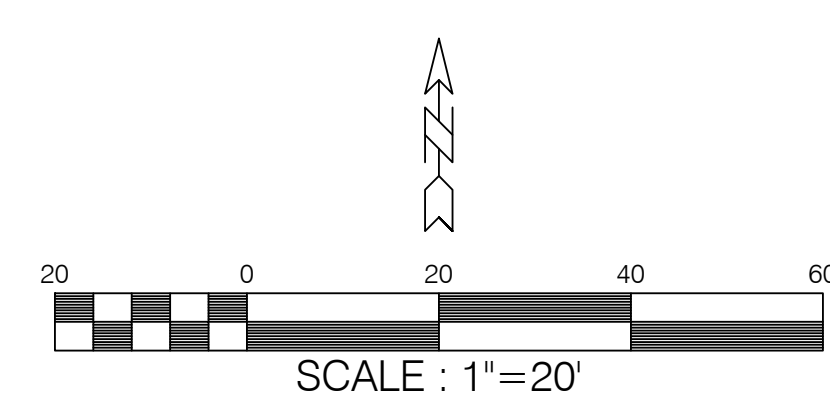
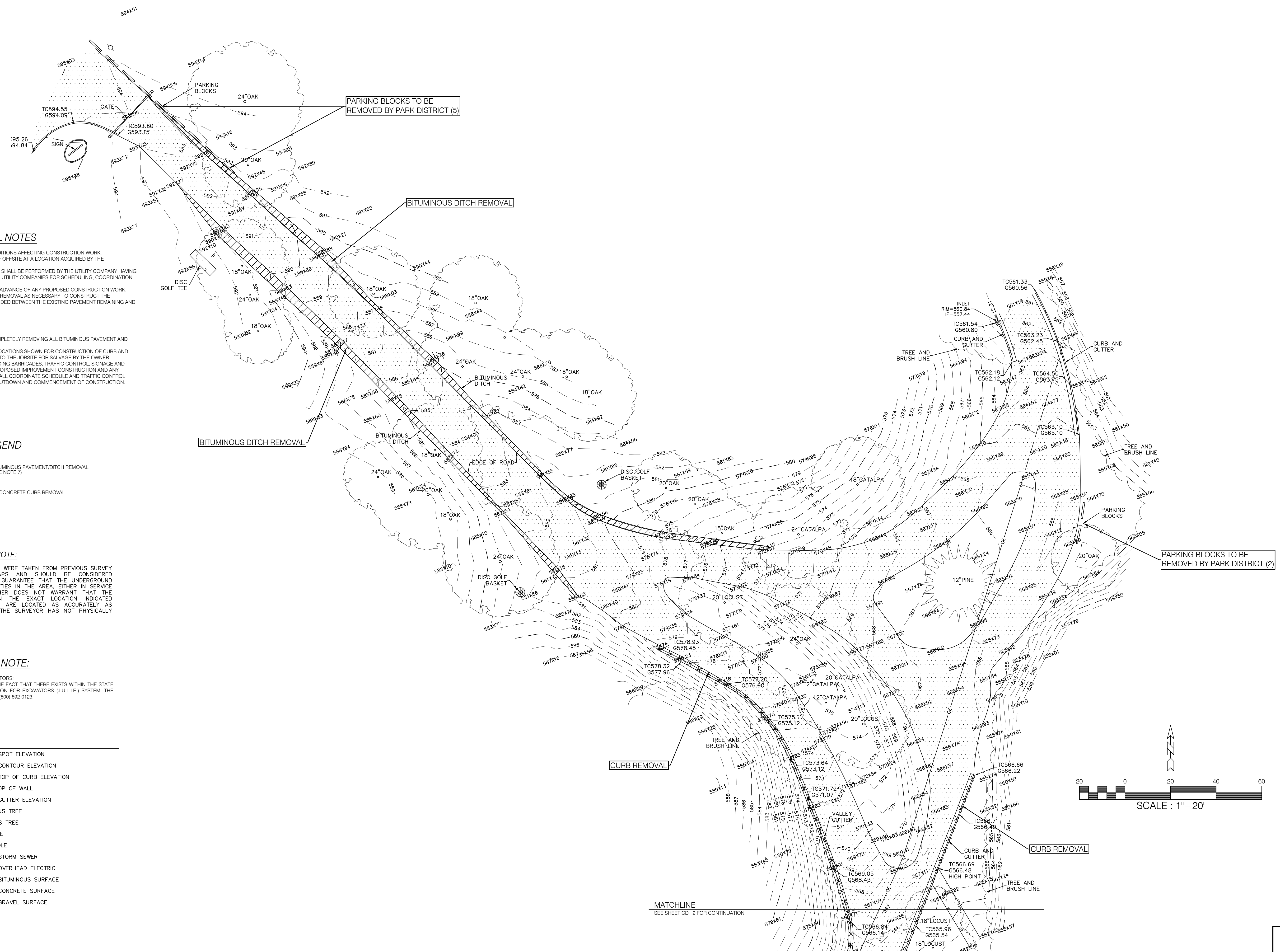

PROJECT MANAGER: TWA	REVISIONS:
APPROVED BY: GRZ	
DATE: MAY 19, 2020	
DWG: 20867 - CD1.1 SITE REMOVAL PLAN - NORTH	
SURVEY BY: MJF	

**ZUMWALT & ASSOCIATES, INC.**  
 PROFESSIONAL ENGINEERS • REGISTERED LAND SURVEYORS  
 1040 W. OLYMPIA DRIVE  
 PEORIA, ILLINOIS • (309) 692-5074  
 DESIGN FIRM REGISTRATION NO. 184-003189

**CURB AND GUTTER IMPROVEMENTS**  
 NORTH/UPPER BRADLEY PARK  
 PEORIA, ILLINOIS

**SITE REMOVAL PLAN - NORTH**

SHT. NO.  
**CD1.1**  
 JOB NO. 20.867

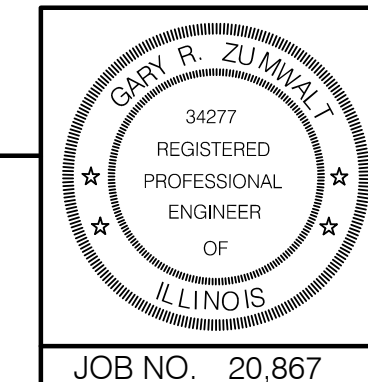

**REMOVAL NOTES**

- SEE GENERAL NOTES ON SHEET C1.1 FOR OTHER CONDITIONS AFFECTING CONSTRUCTION WORK.
- ALL REMOVAL ITEMS SHALL BE PROPERLY DISPOSED OF OFFSITE AT A LOCATION ACQUIRED BY THE CONTRACTOR UNLESS OTHERWISE NOTED.
- UTILITY COMPONENTS TO BE REMOVED OR RELOCATED SHALL BE PERFORMED BY THE UTILITY COMPANY HAVING OWNERSHIP. THE CONTRACTOR SHALL WORK WITH THE UTILITY COMPANIES FOR SCHEDULING, COORDINATION AND LOCATION OF ANY RELOCATION.
- CONTRACTOR SHALL NOTIFY THE OWNER 48 HOURS IN ADVANCE OF ANY PROPOSED CONSTRUCTION WORK.
- THE CONTRACTOR SHALL MAKE ADJUSTMENTS TO THE REMOVAL AS NECESSARY TO CONSTRUCT THE PROPOSED CURB AND ANY BITUMINOUS PATCHING NEEDED BETWEEN THE EXISTING PAVEMENT REMAINING AND THE PROPOSED CURB SHALL BE AS FOLLOWS:  
 BITUMINOUS PATCH  
 4" BITUMINOUS SURFACE COURSE  
 8" CA-6 TYPE B BASE COURSE
- ALL TREE REMOVAL SHALL BE BY OWNER.
- BITUMINOUS PAVEMENT REMOVAL SHALL INCLUDE COMPLETELY REMOVING ALL BITUMINOUS PAVEMENT AND BASE COURSE DOWN TO SUBGRADE.
- EXISTING STONE VALLEY GUTTER TO BE REMOVED AT LOCATIONS SHOWN FOR CONSTRUCTION OF CURB AND GUTTER. ALL STONE SHALL BE STOCKPILED ADJACENT TO THE JOBSITE FOR SALVAGE BY THE OWNER.
- THE CONTRACTOR SHALL BE RESPONSIBLE FOR PROVIDING BARRICADES, TRAFFIC CONTROL, SIGNAGE AND OTHER SAFETY MEASURES FOR CLOSING ROAD FOR PROPOSED IMPROVEMENT CONSTRUCTION AND ANY RELATED CONSTRUCTION ACTIVITIES. CONTRACTOR SHALL COORDINATE SCHEDULE AND TRAFFIC CONTROL MEASURES WITH OWNER 48 HOURS PRIOR TO ROAD SHUTDOWN AND COMMENCEMENT OF CONSTRUCTION.

**LEGEND**

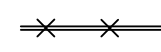
-  BITUMINOUS PAVEMENT REMOVAL (SEE NOTE 7)
-  PC CONCRETE CURB REMOVAL

**UTILITY NOTE:**

UNDERGROUND UTILITIES AS SHOWN HEREON WERE TAKEN FROM PREVIOUS SURVEY INFORMATION OR UTILITY COMPANY MAPS AND SHOULD BE CONSIDERED APPROXIMATE. THE SURVEYOR MAKES NO GUARANTEE THAT THE UNDERGROUND UTILITIES SHOWN COMPRISE ALL SUCH UTILITIES IN THE AREA, EITHER IN SERVICE OR ABANDONED. THE SURVEYOR FURTHER DOES NOT WARRANT THAT THE UNDERGROUND UTILITIES SHOWN ARE IN THE EXACT LOCATION INDICATED ALTHOUGH HE DOES CERTIFY THAT THEY ARE LOCATED AS ACCURATELY AS POSSIBLE FROM INFORMATION AVAILABLE. THE SURVEYOR HAS NOT PHYSICALLY LOCATED THE UNDERGROUND UTILITIES.





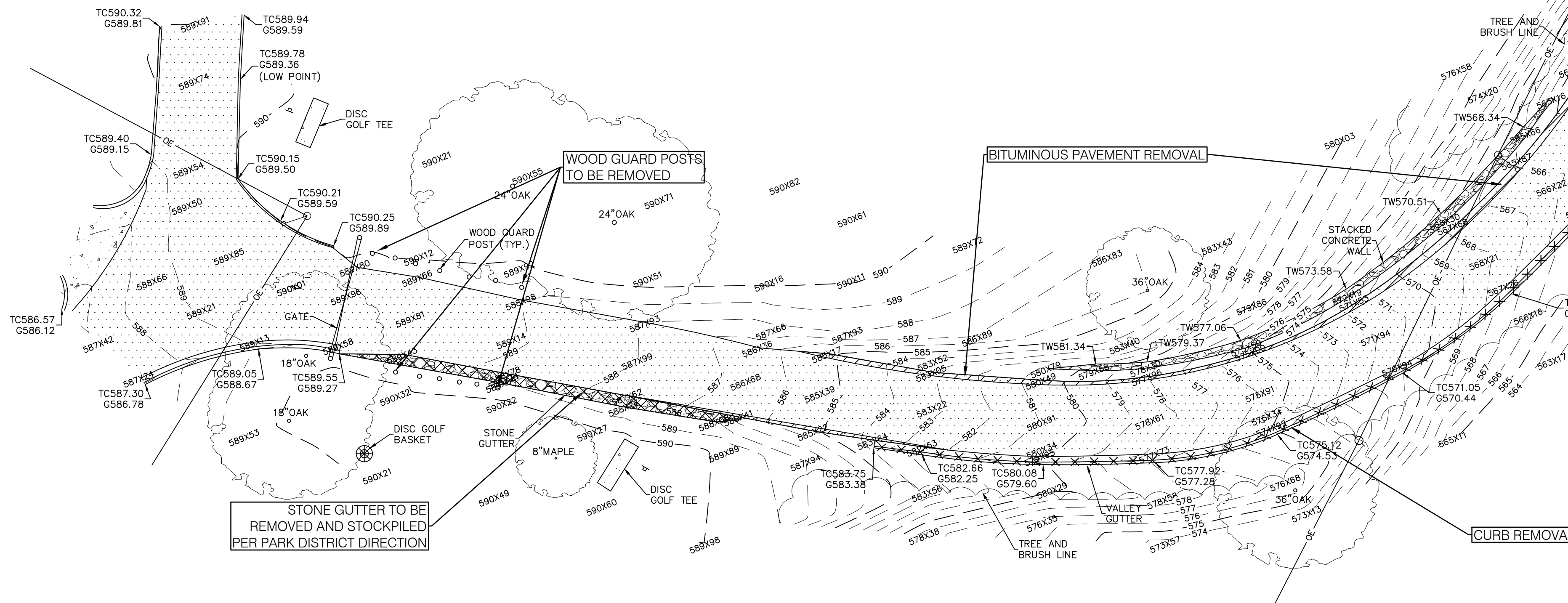

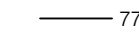

**J.U.L.I.E. NOTE:**

JOINT UTILITY LOCATION INFORMATION FOR EXCAVATORS. THE CONTRACTORS ATTENTION IS DIRECTED TO THE FACT THAT THERE EXISTS WITHIN THE STATE OF ILLINOIS A JOINT UTILITY LOCATION INFORMATION FOR EXCAVATORS (J.U.L.I.E.) SYSTEM. THE TELEPHONE NUMBER FOR THE UTILITY COMPANY IS (800) 892-0123.



MATCHLINE  
SEE SHEET CD1.1 FOR CONTINUATION

**LEGEND**

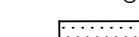
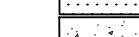
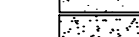
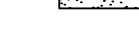
-  EXISTING SPOT ELEVATION
-  EXISTING CONTOUR ELEVATION
-  EXISTING TOP OF CURB ELEVATION
-  EXISTING TOP OF WALL
-  EXISTING GUTTER ELEVATION
-  CONIFEROUS TREE
-  DECIDUOUS TREE
-  LIGHT POLE
-  POWER POLE
-  EXISTING STORM SEWER
-  EXISTING OVERHEAD ELECTRIC
-  EXISTING BITUMINOUS SURFACE
-  EXISTING CONCRETE SURFACE
-  EXISTING GRAVEL SURFACE

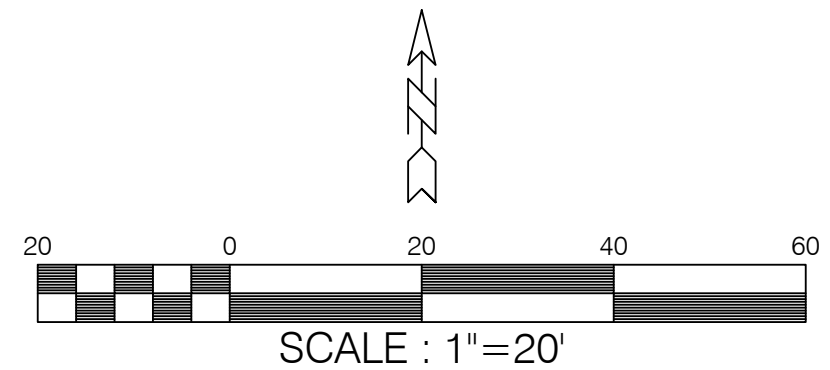

PROJECT MANAGER: TWA	REVISIONS:
APPROVED BY: GRZ	
DATE: MAY 19, 2020	
DWG: 20867 - CD1.2 SITE REMOVAL PLAN - SOUTH	
SURVEY BY: MJF	

**ZUMWALT & ASSOCIATES, INC.**  
 PROFESSIONAL ENGINEERS • REGISTERED LAND SURVEYORS  
 1040 W. OLYMPIA DRIVE  
 PEORIA, ILLINOIS • (309) 692-5074  
 DESIGN FIRM REGISTRATION NO. 184-003189

**CURB AND GUTTER IMPROVEMENTS**  
 NORTH/UPPER BRADLEY PARK  
 PEORIA, ILLINOIS

SITE REMOVAL PLAN - SOUTH

SHT. NO.  
**CD1.2**



JOB NO. 20.867

**GRADING NOTES**

- SEE SHEET V1.1 AND V1.2 FOR EXISTING TOPOGRAPHY AND BENCHMARKS.
- SEE GENERAL NOTES ON SHEET C1.1 FOR OTHER CONDITIONS AFFECTING THE PROJECT.
- SEE SHEET C3.1 FOR THE STORM WATER POLLUTION PREVENTION PLAN AND EROSION CONTROL DETAILS.
- ALL PRECAUTIONS SHALL BE TAKEN TO PREVENT THE TRACKING OF MATERIAL ONTO EXISTING ROADS. THIS SHALL INCLUDE CLEANING MUD AND SEDIMENT FROM TRUCKS BEFORE LEAVING THE SITE AND CLEANING THE EXISTING PAVEMENTS OF ALL MUD AND DEBRIS AT THE END OF EACH DAY'S WORK. CLEANING PAVEMENTS MORE FREQUENTLY SHALL OCCUR WHEN NECESSARY.
- APPROXIMATELY 8 INCHES OF TOP SOIL SHALL BE STRIPPED IN ALL STRUCTURAL AREAS. THE EXACT AMOUNT TO BE DETERMINED BY THE OWNERS REPRESENTATIVE. A MINIMUM OF 6 INCHES OF TOPSOIL SHALL BE PLACED IN ALL DISTURBED AREAS. AFTER CONSTRUCTION OF CURB AND GUTTER, BEHIND CURBS AND CURBED ISLANDS SHALL BE BACKFILLED WITH TOPSOIL AND SHALL BE GRADED TO DRAIN.
- ALL CONCRETE SHALL HAVE A MINIMUM ALLOWABLE COMPRESSIVE STRENGTH OF 4000 P.S.I. (28 DAYS). ALL CONCRETE WORK AND MATERIALS SHALL BE IN ACCORDANCE WITH THE REQUIREMENTS OF SECTION 420 OF THE STATE OF ILLINOIS STANDARD SPECIFICATIONS FOR ROAD AND BRIDGE CONSTRUCTION (LATEST EDITION). CONCRETE JOINT SEALING SHALL BE IN ACCORDANCE WITH THE REQUIREMENTS OF SEC. 420.12 OF THE STATE OF ILLINOIS STANDARD SPECIFICATIONS FOR ROAD AND BRIDGE CONSTRUCTION.

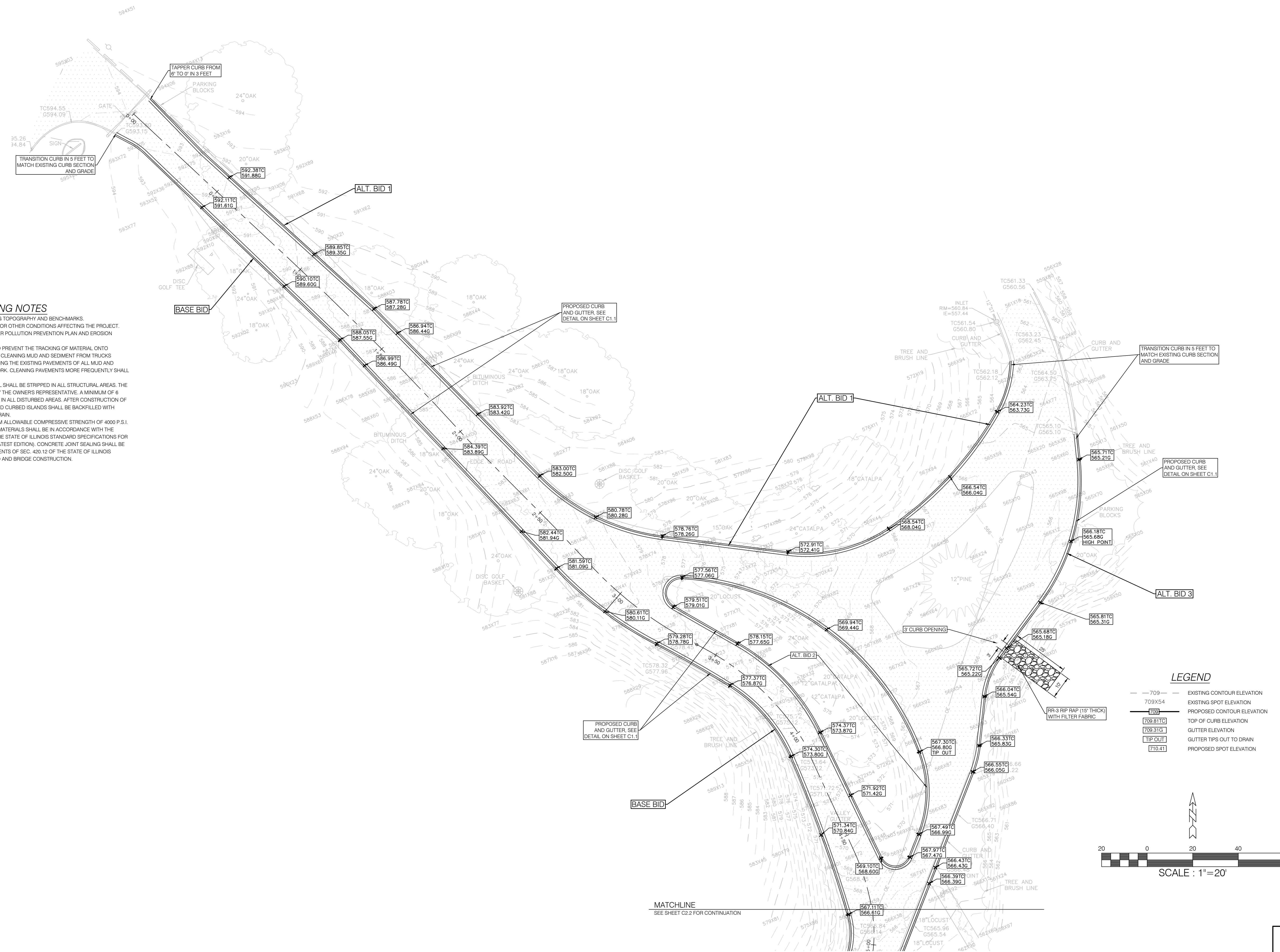

**LEGEND**

---	709	EXISTING CONTOUR ELEVATION
---	709X5.4	EXISTING SPOT ELEVATION
---	709	PROPOSED CONTOUR ELEVATION
---	709.81TC	TOP OF CURB ELEVATION
---	709.31TG	GUTTER ELEVATION
---	TIP OUT	GUTTER TIPS OUT TO DRAIN
---	710.41	PROPOSED SPOT ELEVATION

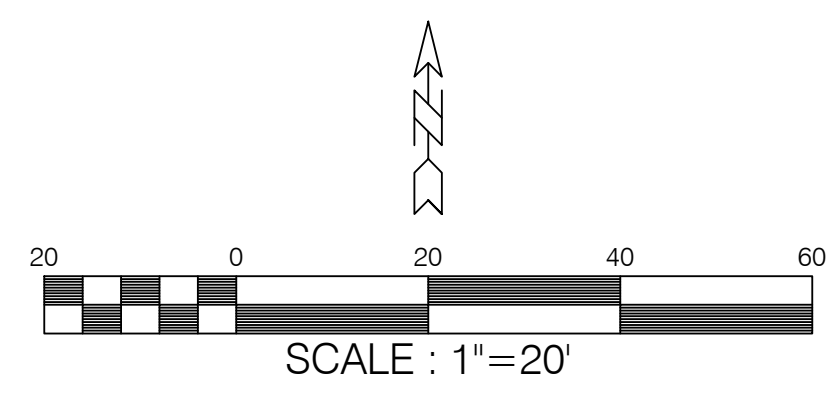

PROJECT MANAGER: TWA
APPROVED BY: GRZ
DATE: MAY 19, 2020
DWG: 20867 - C2.1 SITE GRADING PLAN
SURVEY BY: MJF

REVISIONS:

**ZUMWALT & ASSOCIATES, INC.**  
 PROFESSIONAL ENGINEERS • REGISTERED LAND SURVEYORS  
 1040 W. OLYMPIA DRIVE  
 PEORIA, ILLINOIS • (309) 692-5074  
 DESIGN FIRM REGISTRATION NO. 184-003189

**CURB AND GUTTER IMPROVEMENTS**  
 NORTH/UPPER BRADLEY PARK  
 PEORIA, ILLINOIS

**SITE GRADING PLAN - NORTH**

SHT. NO.  
**C2.1**



JOB NO. 20.867

©COPYRIGHT 2020 ZUMWALT & ASSOCIATES, INC.  
 THIS DOCUMENT IS THE PROPERTY OF ZUMWALT & ASSOCIATES, INC.  
 ANY REPRODUCTION OR UNAUTHORIZED USE IS STRICTLY PROHIBITED

**GRADING NOTES**

- SEE SHEET V1.1 AND V1.2 FOR EXISTING TOPOGRAPHY AND BENCHMARKS.
- SEE GENERAL NOTES ON SHEET C1.1 FOR OTHER CONDITIONS AFFECTING THE PROJECT.
- SEE SHEET C3.1 FOR THE STORM WATER POLLUTION PREVENTION PLAN AND EROSION CONTROL DETAILS.
- ALL PRECAUTIONS SHALL BE TAKEN TO PREVENT THE TRACKING OF MATERIAL ONTO EXISTING ROADS. THIS SHALL INCLUDE CLEANING MUD AND SEDIMENT FROM TRUCKS BEFORE LEAVING THE SITE AND CLEANING THE EXISTING PAVEMENTS OF ALL MUD AND DEBRIS AT THE END OF EACH DAY'S WORK. CLEANING PAVEMENTS MORE FREQUENTLY SHALL OCCUR WHEN NECESSARY.
- APPROXIMATELY 8 INCHES OF TOP SOIL SHALL BE STRIPPED IN ALL STRUCTURAL AREAS. THE EXACT AMOUNT TO BE DETERMINED BY THE OWNERS REPRESENTATIVE. A MINIMUM OF 6 INCHES OF TOPSOIL SHALL BE PLACED IN ALL DISTURBED AREAS. AFTER CONSTRUCTION OF CURB AND GUTTER, BEHIND CURBS AND CURBED ISLANDS SHALL BE BACKFILLED WITH TOPSOIL AND SHALL BE GRADED TO DRAIN.
- ALL CONCRETE SHALL HAVE A MINIMUM ALLOWABLE COMPRESSIVE STRENGTH OF 4000 P.S.I. (28 DAYS). ALL CONCRETE WORK AND MATERIALS SHALL BE IN ACCORDANCE WITH THE REQUIREMENTS OF SECTION 420 OF THE STATE OF ILLINOIS STANDARD SPECIFICATIONS FOR ROAD AND BRIDGE CONSTRUCTION (LATEST EDITION). CONCRETE JOINT SEALING SHALL BE IN ACCORDANCE WITH THE REQUIREMENTS OF SEC. 420.12 OF THE STATE OF ILLINOIS STANDARD SPECIFICATIONS FOR ROAD AND BRIDGE CONSTRUCTION.

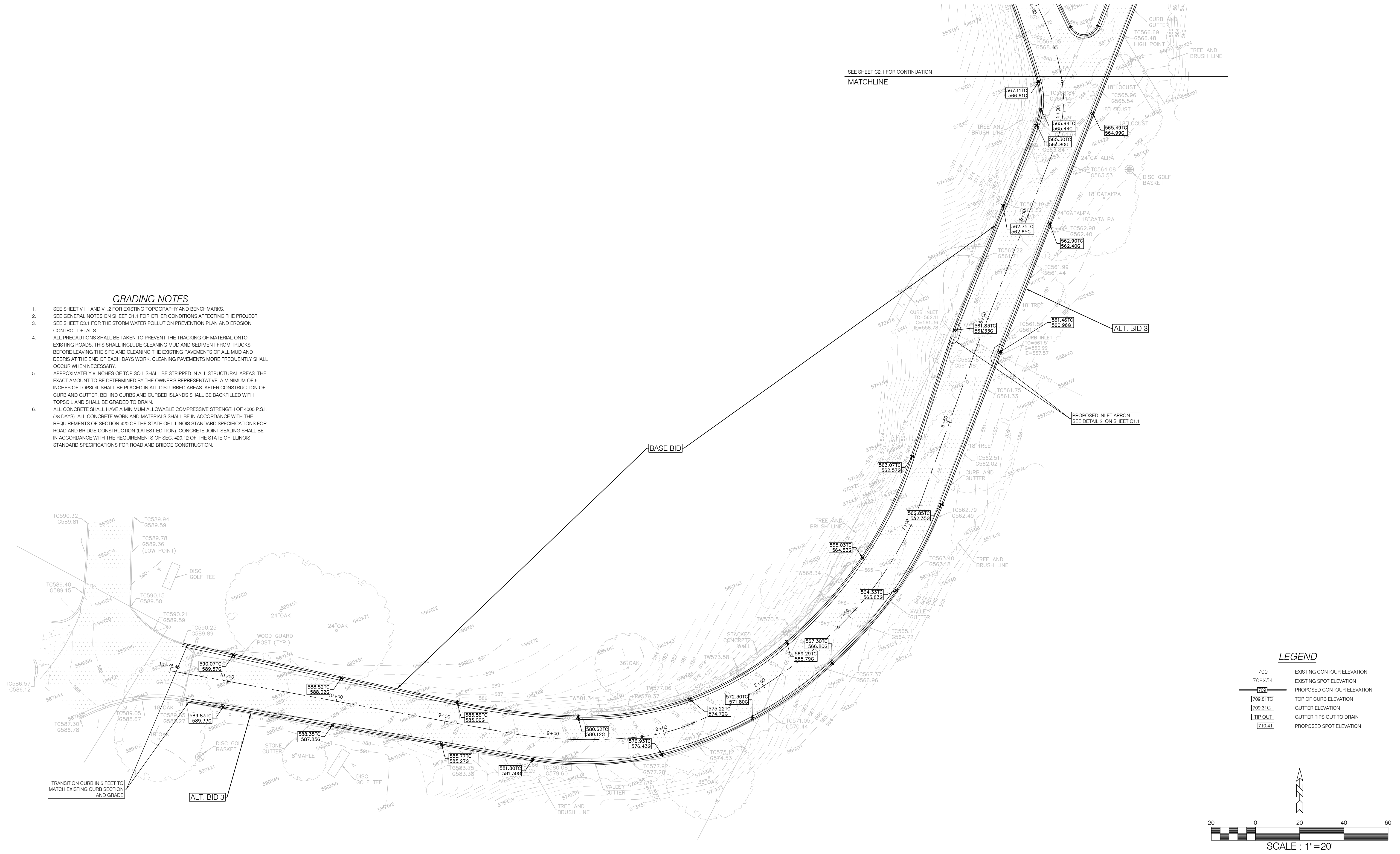

**LEGEND**

---	709	EXISTING CONTOUR ELEVATION
---	709X54	EXISTING SPOT ELEVATION
---	709	PROPOSED CONTOUR ELEVATION
---	709.81TC	TOP OF CURB ELEVATION
---	709.31G	GUTTER ELEVATION
---	TIP OUT	GUTTER TIPS OUT TO DRAIN
---	710.41	PROPOSED SPOT ELEVATION

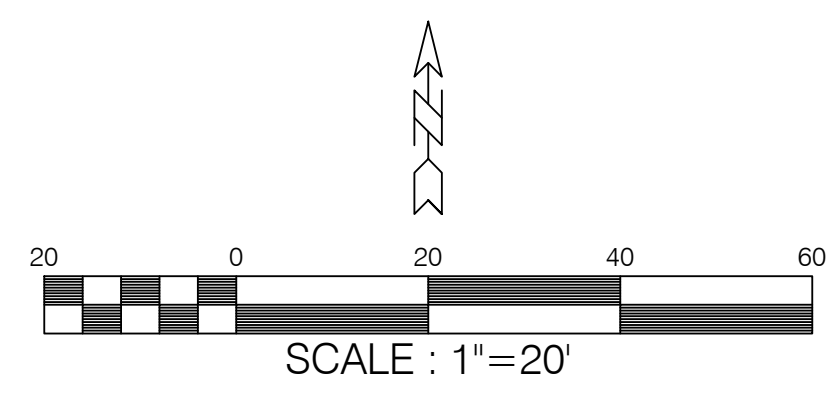

PROJECT MANAGER: TWA
APPROVED BY: GRZ
DATE: MAY 19, 2020
DWG: 20867 - C2.2 SITE GRADING PLAN
SURVEY BY: MJF

REVISIONS:

**ZUMWALT & ASSOCIATES, INC.**  
 PROFESSIONAL ENGINEERS • REGISTERED LAND SURVEYORS  
 1040 W. OLYMPIA DRIVE  
 PEORIA, ILLINOIS • (309) 692-5074  
 DESIGN FIRM REGISTRATION NO. 184-003189

**CURB AND GUTTER IMPROVEMENTS**  
 NORTH/UPPER BRADLEY PARK  
 PEORIA, ILLINOIS

**SITE GRADING PLAN - SOUTH**

SHT. NO.  
**C2.2**



©COPYRIGHT 2020 ZUMWALT & ASSOCIATES, INC.  
 THIS DOCUMENT IS THE PROPERTY OF ZUMWALT & ASSOCIATES, INC.  
 ANY REPRODUCTION OR UNAUTHORIZED USE IS STRICTLY PROHIBITED

**EROSION CONTROL NOTES**

- PROJECT DESCRIPTION - PROJECT CONSISTS OF ALL SITE AND UTILITY WORK ASSOCIATED WITH THE CONSTRUCTION OF THE PROPOSED SITE IMPROVEMENTS AS SHOWN ON THESE PLANS.
- APPROXIMATE SITE AREA TO BE GRADED OR EXCAVATED = 0.30 ACRES±.
- EROSION AND SEDIMENT CONTROL MEASURES:
  - SILT FENCE SHALL BE PLACED WHERE SHOWN ON THIS PLAN.
  - PROVIDE TEMPORARY PIT OR BERMED AREA AT LOCATION TO BE DETERMINED BY OWNERS REPRESENTATIVE FOR WASHOUT OF CONCRETE TRUCKS, TOOLS, MORTAR MIXES, ETC.
  - ALL PRECAUTIONS SHALL BE TAKEN TO PREVENT THE TRACKING OF MATERIAL ONTO EXISTING ROADS. THIS SHALL INCLUDE CLEANING MUD AND SEDIMENT OFF OF TRUCKS BEFORE LEAVING THE SITE AND CLEANING EXISTING PAVEMENTS OF ALL DIRT, MUD AND DEBRIS AT THE END OF EACH DAY'S WORK. CLEANING PAVEMENTS MORE FREQUENTLY SHALL ALSO OCCUR WHEN NECESSARY.
  - DUST CONTROL SHALL BE PROVIDED BY WATERING OR OTHER MEANS TO KEEP DUST TO A MINIMUM DURING CONSTRUCTION.
- CONSTRUCTION WASTE: ALL CONSTRUCTION WASTE MATERIALS WILL BE COLLECTED AT REGULAR INTERVALS AND DISPOSED OF IN ACCORDANCE WITH LOCAL AND STATE WASTE MANAGEMENT REGULATIONS. NO CONSTRUCTION WASTE MATERIALS WILL BE BURIED ONSITE. ALL PERSONNEL WILL BE INSTRUCTED REGARDING THE CORRECT PROCEDURE FOR CONSTRUCTION WASTE DISPOSAL. NOTICES STATING THESE PRACTICES WILL BE POSTED AT THE CONSTRUCTION OFFICE.
  - HAZARDOUS WASTE: ALL HAZARDOUS WASTE MATERIALS WILL BE DISPOSED OF IN THE MANNER SPECIFIED BY LOCAL OR STATE REGULATION OR BY THE MANUFACTURER.
  - SANITARY WASTE: ALL SANITARY WASTE WILL BE COLLECTED FROM PORTABLE UNITS BY A LICENSED SANITARY WASTE MANAGEMENT CONTRACTOR, AS REQUIRED BY LOCAL REGULATIONS.
- MAINTENANCE AND INSPECTION: ALL CONTROL MEASURES WILL BE INSPECTED AT LEAST ONCE PER WEEK AND FOLLOWING ANY STORM EVENT OF 1/2 INCH OR GREATER. ALL MEASURES WILL BE MAINTAINED IN GOOD WORKING ORDER. IF REPAIR IS NECESSARY, IT WILL BE MADE AS SOON AS PRACTICAL AFTER DAMAGE OCCURS. A MAINTENANCE INSPECTION REPORT WILL BE MADE AFTER EACH INSPECTION. INSPECTION SERVICES TO BE PROVIDED BY THE CONTRACTOR.
- COPIES OF THE STORM WATER POLLUTION PREVENTION PLAN WILL BE RETAINED ONSITE BY THE CONTRACTOR AT ALL TIMES.
- CONTRACTOR SHALL VERIFY THE LOCATION OF ALL UTILITIES IN THE FIELD PRIOR TO COMMENCING CONSTRUCTION WORK.
- ALL DISTURBED AREAS SHALL BE SEED, FERTILIZED, AND MULCHED AS FOLLOWS:
  - SEEDING SHALL BE CLASS 1 IN ACCORDANCE WITH THE STATE OF ILLINOIS 'STANDARD SPECIFICATIONS FOR ROAD AND BRIDGE CONSTRUCTION'.
  - FERTILIZING FOR THE SEEDING AREAS SHALL HAVE A RATIO OF 12N-12P-12K AND SHALL BE APPLIED AT THE RATE OF 270 POUNDS PER ACRE. (60 POUNDS EACH NITROGEN, PHOSPHORUS, AND POTASSIUM)
  - MULCH SHALL BE METHOD 1, STATE OF ILLINOIS STANDARDS.

**SILT FENCE DETAIL**

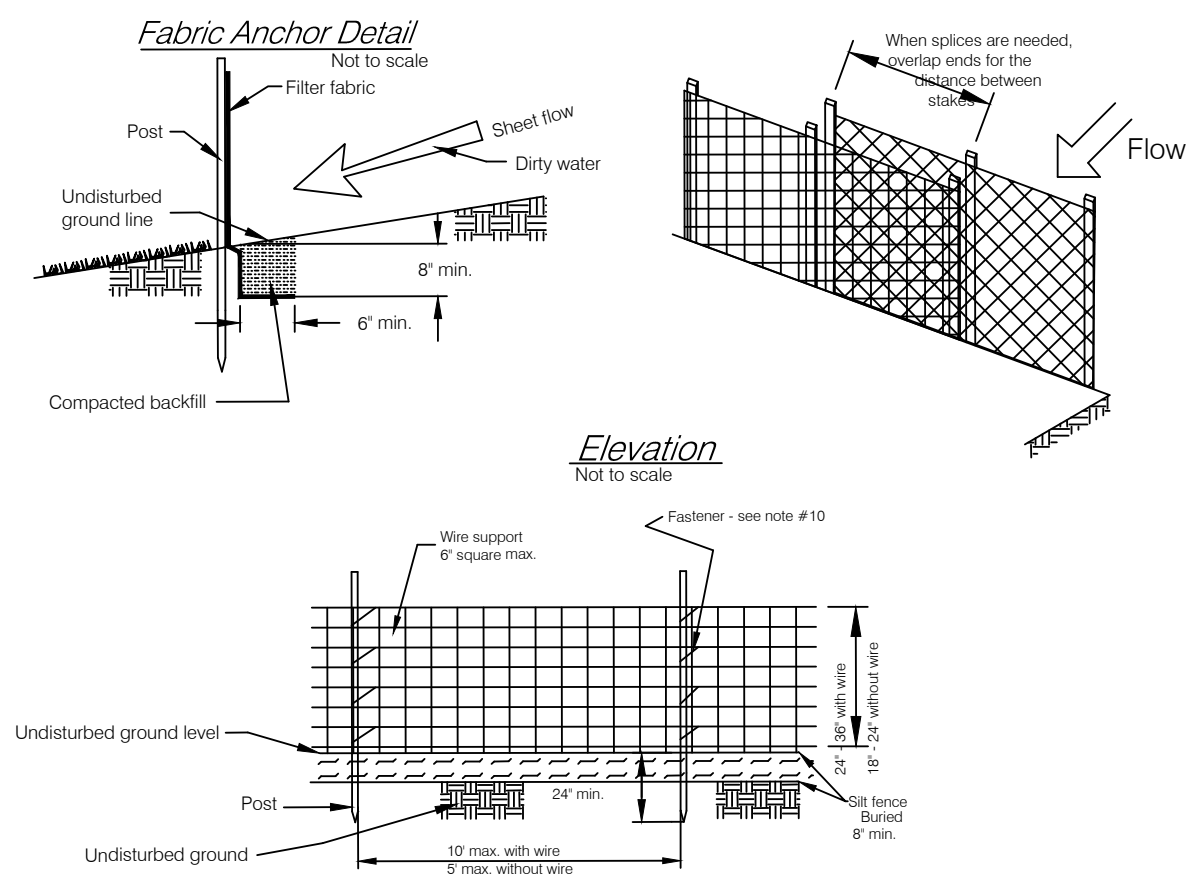

- When splices are necessary, the fabric shall be spliced between support posts, with a minimum overlap equal to the distance between posts.
  - The silt fence shall be entrenched to a minimum depth of 8 inches, with an additional 6 inches extending along the bottom of the trench in the up-slope direction. The trench shall be backfilled and the soil compacted over the fabric.
  - The filter fabric and wire support, if used, must be securely fastened to the posts using one inch long heavy duty wire staples, tie wires, or hog rings. The fabric shall not be stapled to trees.
  - The fence shall be installed as close to the contour as possible, with the ends extending up-slope. The area below the silt fence must be undisturbed or stabilized.
- Applicability**  
A standard sheet flow silt fence is a temporary barrier of entrenched filter fabric stretched across and attached to supporting posts. It is used to catch dirty runoff from small drainage areas of disturbed soil. This practice shall only be installed in areas where runoff is in the form of sheet flow. The purpose of this practice is to cause dirt to drop out of the water and prevent it from leaving disturbed areas. The maximum allowable slope lengths contributing to a standard sheet flow silt fence are:
- | % Slope | Maximum Spacing (ft) |
|---------|----------------------|
| 25      | 50                   |
| 20      | 75                   |
| 15      | 125                  |
| 10      | 175                  |
| <10     | 200                  |
- When the disturbed slope is longer than the maximum spacing, add additional parallel rows of silt fence to the slope so that the distance is in the allowable range.
  - Silt fence may be used where long-term effectiveness is required.
- Operation and Maintenance**
- Silt fences shall be inspected immediately after each rainfall and at least once a day during prolonged rainfall.
  - Dirt should be removed after each rainfall; it MUST be removed when it reaches one-half the fence height.
  - Erosion resulting from end-cuts or under cuts shall be repaired immediately.
  - All loose fence material or falling posts shall be repaired immediately.
  - Silt fences shall remain in place and be fully functional until the area being protected is permanently stabilized.
  - Any dirt deposits remaining in place after the silt fence is no longer required shall be dressed to conform to the existing grade, a seedbed prepared, and the site vegetated.
- Inspection Checklist**
- Verify that the silt fence is installed in the appropriate location - down-slope of the disturbed area. Check to see if all necessary areas (where runoff leaves the site) are protected.
  - Verify that the silt fence is installed as close to the contour as practical.
  - Check to see if the splices (when needed) overlap a minimum of one post length and are secured tightly.
  - Check post spacing: Fabric only - 5 ft. maximum; Fabric with wire support - 10 ft. maximum.
  - Check the height of the fence:
 

With wire	Without wire
24 inches min. - 36 inches max.	18 inches min. - 24 inches max.
  - Check to see that the fabric is entrenched a minimum of eight inches, with an additional six inches of fabric extending uphill (buried).
  - Check to see if maintenance is needed.

**SILT SACK - TYPE B**

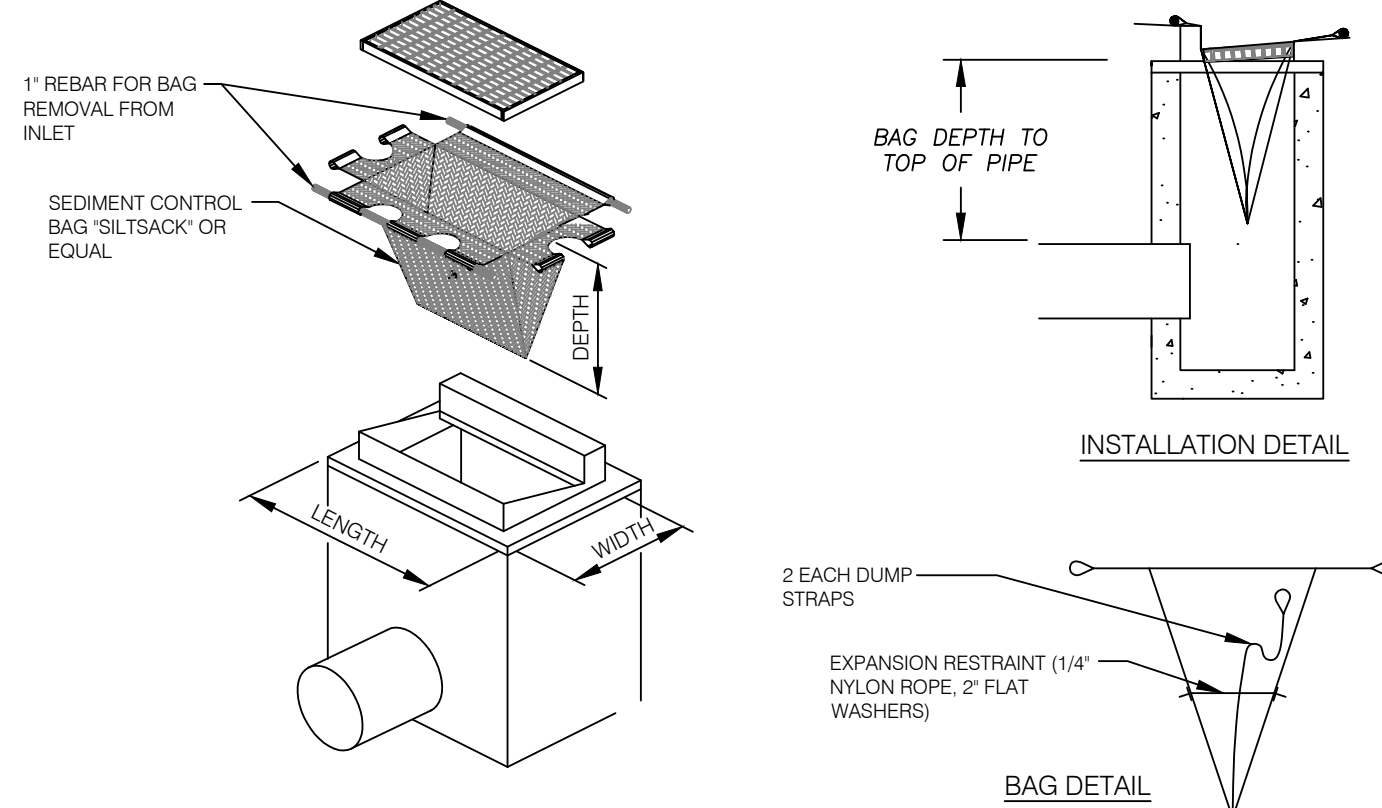

- NOTES:**
- THE SEDIMENT CONTROL DEVICE SHALL BE INSPECTED DAILY BY THE CONTRACTOR AND MAINTAINED A MINIMUM ONCE PER MONTH OR WITHIN THE 48 HOURS FOLLOWING A STORM EVENT. FILTER SHALL BE CLEANED IN A MANNER WHICH ENSURES THAT ALL SEDIMENT REMAINS ON SITE.
  - SUBSTITUTION OF A SHEET OF FILTER FABRIC PLACED OVER THE OPENING OF THE INLET IS NOT APPROVED.
  - THE FILTER SHALL BE REPLACED OR CLEANED WHEN THE BAG BECOMES HALF FULL.

**INLET PROTECTION DETAIL**

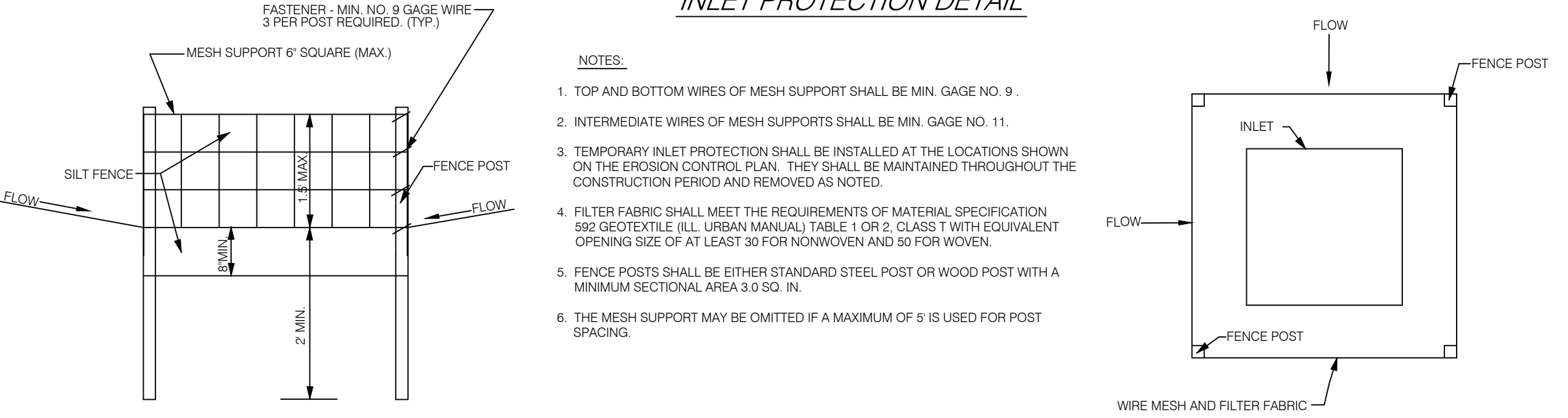

- NOTES:**
- TOP AND BOTTOM WIRES OF MESH SUPPORT SHALL BE MIN. GAGE NO. 9.
  - INTERMEDIATE WIRES OF MESH SUPPORTS SHALL BE MIN. GAGE NO. 11.
  - TEMPORARY INLET PROTECTION SHALL BE INSTALLED AT THE LOCATIONS SHOWN ON THE EROSION CONTROL PLAN. THEY SHALL BE MAINTAINED THROUGHOUT THE CONSTRUCTION PERIOD AND REMOVED AS NOTED.
  - FILTER FABRIC SHALL MEET THE REQUIREMENTS OF MATERIAL SPECIFICATION 592 GEOTEXTILE (ILL. URBAN MANUAL) TABLE 1 OR 2, CLASS T WITH EQUIVALENT OPENING SIZE OF AT LEAST 30 FOR NONWOVEN AND 50 FOR WOVEN.
  - FENCE POSTS SHALL BE EITHER STANDARD STEEL POST OR WOOD POST WITH A MINIMUM SECTIONAL AREA 3.0 SQ. IN.
  - THE MESH SUPPORT MAY BE OMITTED IF A MAXIMUM OF 5' IS USED FOR POST SPACING.

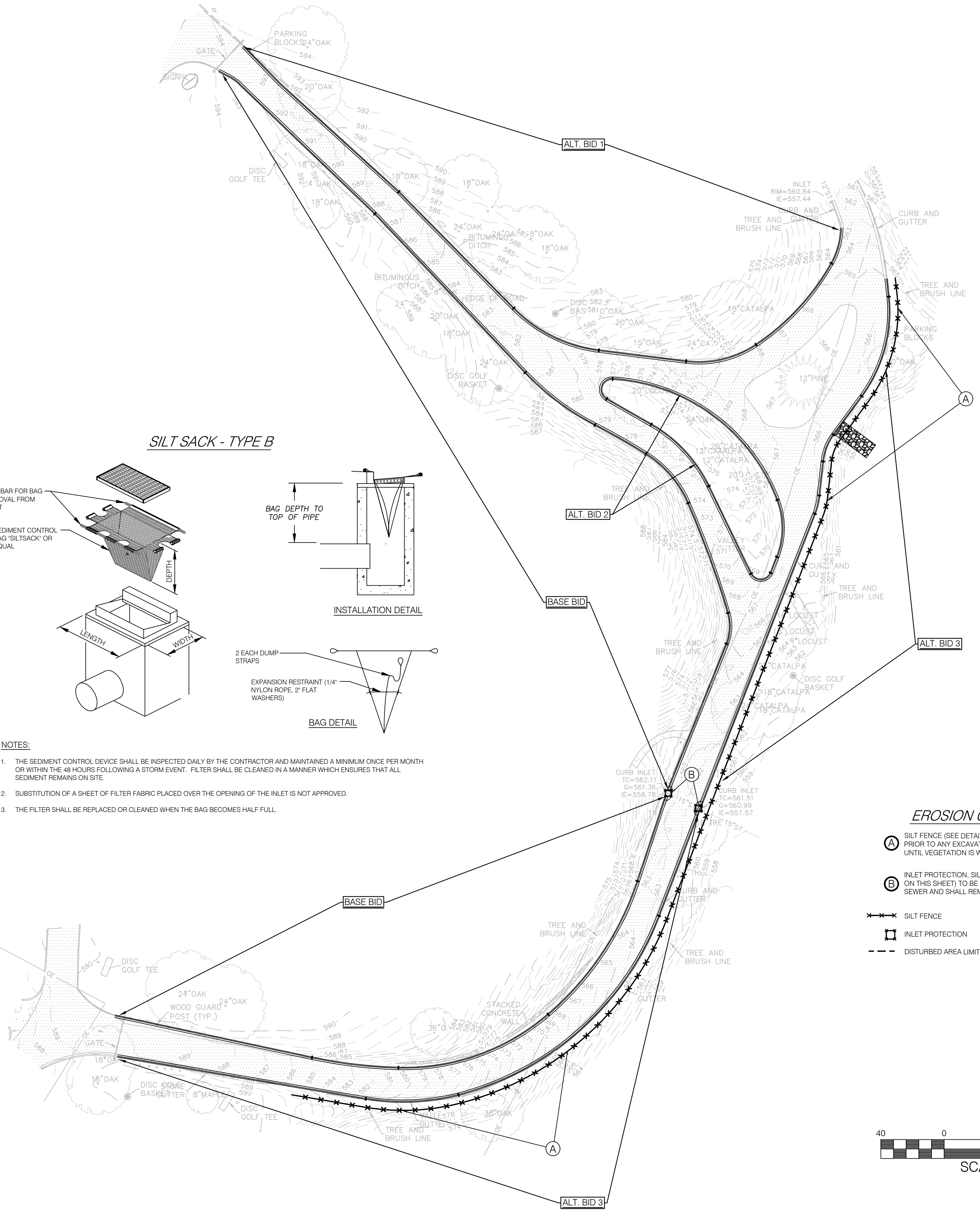

**EROSION CONTROL LEGEND**

- (A) SILT FENCE (SEE DETAIL ON THIS SHEET) TO BE INSTALLED PRIOR TO ANY EXCAVATION OR CONSTRUCTION AND TO REMAIN UNTIL VEGETATION IS WELL ESTABLISHED.
- (B) INLET PROTECTION, SILT SACK OR APPROVED EQUAL (SEE DETAILS ON THIS SHEET) TO BE INSTALLED AFTER CONSTRUCTION OF STORM SEWER AND SHALL REMAIN UNTIL VEGETATION IS WELL ESTABLISHED.
- SILT FENCE
- INLET PROTECTION
- - - DISTURBED AREA LIMITS

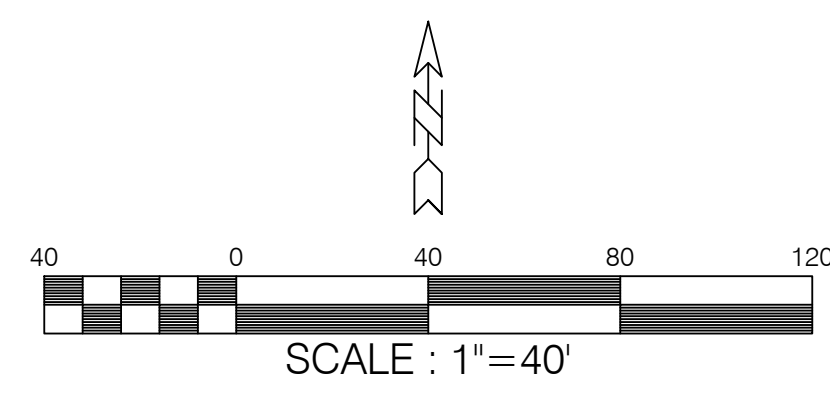

PROJECT MANAGER: TWA	REVISIONS:
APPROVED BY: GRZ	
DATE: MAY 19, 2020	
DWG: 20867 - C3.1 SWPPP	
SURVEY BY: MJF	

**ZUMWALT & ASSOCIATES, INC.**  
 PROFESSIONAL ENGINEERS • REGISTERED LAND SURVEYORS  
 1040 W. OLYMPIA DRIVE  
 PEORIA, ILLINOIS • (309) 692-5074  
 DESIGN FIRM REGISTRATION NO. 184-003189

**CURB AND GUTTER IMPROVEMENTS**  
 NORTH/UPPER BRADLEY PARK  
 PEORIA, ILLINOIS

**STORM WATER POLLUTION PREVENTION**  
 PLAN, DETAILS AND NOTES

SHT. NO.  
**C3.1**  
 JOB NO. 20.867



©COPYRIGHT 2020 ZUMWALT & ASSOCIATES, INC.  
 THIS DOCUMENT IS THE PROPERTY OF ZUMWALT & ASSOCIATES, INC.  
 ANY REPRODUCTION OR UNAUTHORIZED USE IS STRICTLY PROHIBITED